



UNSW
SYDNEY

School of Electrical Engineering and Telecommunications

SECURED COMMUNICATION IN SWIPT NETWORKS

Surabattuni Ramakrishna

Supervisor: Dr Derrick Wing Kwan Ng

A Thesis Submitted to

University of New South Wales

For the degree of
Master of Engineering Science (Telecommunication)

2017

Date of Submission: 01/06/2017

Contents

Abstract.....	vi
Abbreviations.....	vii
Notations.....	vii
1. INTRODUCTION:.....	1
2. Literature Survey.....	3
3. Background.....	5
4. Wireless Powered Communication Network Model.....	6
4.1 Wireless Energy Transfer.....	6
4.2 Simultaneous Wireless Information and Power Transfer.....	6
4.3 Wireless Powered communication networks.....	6
5. Simultaneous Wireless Information and Power Transfer.....	7
5.1 SWIFT Communication System Models.....	7
5.1.1 Integrated-SWIPT.....	7
5.1.2 Decoupled SWIPT.....	7
5.1.3 Closed-Loop SWIPT.....	8
6. Physical layer Techniques of SWIPT.....	9
6.1 Energy Beamforming:.....	9
6.2 Wireless Channel and Resource Allocation in SWIPT Systems.....	10
6.2.1 Conditions for Efficient WPT.....	10
6.2.2 Channel State Information.....	10
6.2.3 Resource Allocation for Systems with SWIPT.....	11
6.2.4 Joint power control and user scheduling.....	11
6.2.5 Energy and information scheduling.....	11
7. Antenna Structure for the Energy Harvesters:.....	12
8. Receiver Structures for Wireless Powered Communication.....	13
8.1 Time Switching.....	13
8.2 Power Splitting.....	13
8.3 Spatial Switching.....	14
8.4 Antenna Switching.....	14
8.5 The Range of the wireless communication for the Mobile devices.....	14
9. Research and Design Challenges.....	15
9.1 Safety Issues.....	15
9.2 Hardware Implementation.....	16

9.3 Energy and information transfer coexistence.....	16
9.4 Energy and information transfer coexistence.....	16
9.5 Cross-layer design.....	16
10. Security Issues in SWIPT Communication.....	17
10.1 SWIPT in Broadcasting Channels.....	17
10.1.1 Different sensitivity ranges of receivers	17
10.1.2 Cooperative eavesdropping.....	17
10.1.3 Inter-user interference	17
10.2 SWIPT protocol in Relaying systems	18
10.2.1 Untrusted Relay	18
10.2.2 Unsecured Transmission	18
10.3 SWIPT Protocol in Interference Networks	19
10.3.1 Uncoordinated Transmission	19
10.3.2 Unavailability of channel state information (CSI):	19
10.3.3 Conflicting objectives	20
10.4 SWIPT in Wireless Powered Communication Networks	20
10.4.1 Difficulty in performing joint resource allocation	20
10.4.2 Weak anti-eavesdropper capability	20
10.5 SWIPT protocol in Cognitive Radio Networks (CRN):	21
10.5.1 Open Architecture	21
10.5.2 Restricted secure scheme	21
10.5.3 Interference management.....	21
11. Physical layer Techniques for Security issues in SWIPT systems.....	23
11.1 Multiple Antennas at the Transmitter side.....	23
11.2 Artificial Noise.....	23
11.3 Resource allocation	24
11.4 Relay Selection	25
12. Proposed Scheme	26
12.1 System Model	26
12.2 Maximum Capacity Rate of Eavesdropper	28
13. RESULTS	32
14. Conclusion	34
15. REFERENCES	35
16. Theorem Proofs.....	42
16.1 Proof of Theorem1	42
16.2 Proof of Proposition.1	43

List of Figures

Figure 1: IoT applications in the different Domains	2
Figure 2: Wireless Powered Communication (WPC) network model	6
Figure 3: Different types of SWIPT communication	7
Figure 4: Different modes of SWIPT system based on the link	8
Figure 5: Beamforming with multi-antenna at the transmitter side.	9
Figure 6: The beam efficiency of the power beam and it's dependency parameters factors	10
Figure 7: Rectenna-diode and their dependency on various Parameters	12
Figure 8: Rectenna-diode and their dependency on various Parameters	13
Figure 9: Wireless information and energy Transformation with power splitting receiver	13
Figure 10: Challenges in SWIPT communication systems	15
Figure 11: Different ranges of UMDI for different number of Antennas	15
Figure 12: Relay based Communication in SWIPT	18
Figure 13: SWIPT Protocol in Interference Communication	19
Figure 14: SWIPT Protocol in Wireless Powered Communication	20
Figure 15: SWIPT Protocol Cognitive Radio Network	22
Figure 16: Beam forming in "MIMO" system	23
Figure 17: Beam forming in SWIPT system	24
Figure 18: Transmitter beam form towards the Eavesdropper	28
Figure 19: Secrecy rate versus different power transmit power level for different level transmit antennas	32
Figure 20: The Average secrecy rate versus different level of Energy receivers	33

Abstract: The Power carrying capability of RF signals have become an optimal solution for the charging up the small sensor networks which are non-feasible for periodic replacements. In wireless powered communication, power signals also occupy the certain bandwidth as the information due to modulated wave. It uses the random sequence for modulation, unlike the conventional oscillation signals. Furthermore, In order to mitigate the interference between the energy and transmitter signals, we exploit the typical orthogonal frequencies. This procedure is not only spectral inefficiency but also consumes the communication resource (bandwidth). But, a novel-technique called SWIPT enabling the simultaneous transmission of both information and energy of the signal. SWIPT communication has the capability of sharing of the given resources is circumvent Problem due to the scarcity of resources (power, bandwidth) in communication. The new technologies such as the Smart Antenna Systems, high microwave Generators, millimetre-wave communication, Invention of the Rectantenna, and optimum beam forming techniques realize and facilitate the further Improvement. However, there are many research and technical Problems like Hardware Realization, Cross-layer design, safety issues etc. In addition, the different sensitivity ranges of Energy harvesters and Information Decoders lead to the problem of Information leakage due to the potential eavesdroppers.

The proposed research aims to mitigate the Information leakage problem by using the convex optimization methods. Semi Definite Programming (SDP), Karush–Kuhn–Tucker (KKT) conditions, Lagrangian dual Problem, and one-dimensional search introduced for solving the proposed problem. Secrecy rate calculated for different number of transmitting antennas for given power. Finally, we compared the our optimal scheme with the baseline scheme.

Index Terms: Multi Input Multi Output (MIMO), resource allocation, Channel state information (CSI), Physical layer, Semi definite programming (SDP), Simultaneous wireless information and power transfer (SWIPT), Karush–Kuhn–Tucker (KKT).

Abbreviations:

MIMO – Multi-input Multi-output

SDP- Semi Definite Programme

CV Optimization – Convex Optimization

SWIPT – Simultaneous Wireless Information and Power Transmission

KKT - Karush–Kuhn–Tucker

CSI - Channel state information

Notations:

In this report, bold letters represent the matrices and small letters represent the vectors.

\mathbf{W}_E –Energy signal matrix

\mathbf{W} - Information signal Matrix

σ_{ant}^2 – Noise power Due to Antenna

σ_s^2 - Noise power due to Signal Processing

Trace (\mathbf{W}_E) – Total Power of Energy Signal

Trace (\mathbf{W}) – Total power of Information Signal

\mathbf{h} – Channel vector between the transmitter and the information receiver

ρ – Power splitting ratio

P_{\max_n} – Maximum transmit power of antenna n

P_{\max} – Transmitter maximum Power

Γ_{req} –Minimum required signal-to-noise-plus-interference ratio

N_T – Number of transmitter antennas,

N_R – Number of receiver antennas.

1. INTRODUCTION:

In the present days, IoT devices, wireless networks, and other mobile electronic devices have become critical components in both academic and non-academic fields [1]. Especially, IoT devices are playing a leading role in gigantic industries for applications such as security devices, monitoring activities etc. Small sensor networks are using for the medical purposes and embedding in big complicated devices for monitoring their internal structure [1-2]. According to the Intel survey, 6.4 billion of the Internet of Things(IoT) are using in the 2016, and this can reach up to 30% increment in next year [1]. Thus, we can see the importance of their applications. However, battery life became the main constraint for their perpetual performance. The battery is the key component and supplies enough energy for both transmitting the data and signal processing. The small sensors which are embedded in big devices may not be feasible for periodical replacements, especially, sensors using for medical purposes. The development of near-field technologies like: “*Inductive coupling*” [6], “*Magnetic coupling*” [7] reduces these issues. However, they are distance restrain and not flexible. On the other hand, the capability of power carrying of Radio waves leads to the development of the new technology called RF-enabled wireless energy transfer (WET) [8]. It is an optimal and feasible solution to transform the energy over the air. Furthermore, it is completely flexible and can support for long distances. In WET, the wireless receivers harvested the energy separately from RF signals by “using the far-field radiative properties of electromagnetic (EM) wave” [8]. Originally, this idea was invented and experimented by “Nicola Teslain” in 1899. However, this Technology did not become famous till 1960 as of the health concern and low transmission efficiency prevented it from being improved further for long distance transmission. The development of smart antenna technology (MIMO, large-scale antenna arrays), high power microwave generators and the invention of the Rectantenna overcome the all technical, health related problems. This novel technology has many feasible advantages such as: small receiver form factor, low production cost, long period of operating range, and energy multicasting due to multicast nature of EM waves. Thus, based on the working mechanism, the existing Wireless energy transmission (WET) technology categorized into three classes namely: “*Inductive Coupling*” [3], “*Magnetic Coupling*” [4], and *EM-Wave Radiation* [4, 5]. Inductive coupling technology exploits the “*non-radiative near-field EM properties affiliated with an antenna for short-range high-power transfer*” [6]. Presently, this is the standardized procedure for charging implanted medical devices, mobile phones etc. Magnetic induction is mainly depending on the distance. So, it mainly uses for the range of several meters. However, magnetic coupling could support long distance compare to Inductive coupling. This is also using the “*non-radiative near-field EM properties affiliated with an antenna for short-range high-power-transfer*” [7]. However, positioning of the receiver is important for this application. Additionally, power transfer to multiple antennas requires a careful tuning for mitigating the interference. On the other hand, wave Radiation is also called RF-enabled Wireless energy transmission. *It leverages far-field radiative properties of EM waves for long distance communication*

[8]. Nowadays, the energy demand of simple wireless devices reduced significantly due to advance improvement in silicon technology [4]. So, RF-enabled Wireless energy became fascinating technology to sustain the lifetime of batteries.

$$Distance_{EM\ Wave\ Radiation} > Distance_{Magnetic\ coupling} > Distance_{Inductive\ coupling}$$

The EM power mainly relies on the distance. Thus Propagation range is constrained by the distance and power harvested is in the range of mile-watt. However, this technology can be the promising technology for cutting the wire if the two main challenges, high propagation loss, and safety concerns can be overcome. Health hazard is the core challenge and obstacle for further improvement of this technology.

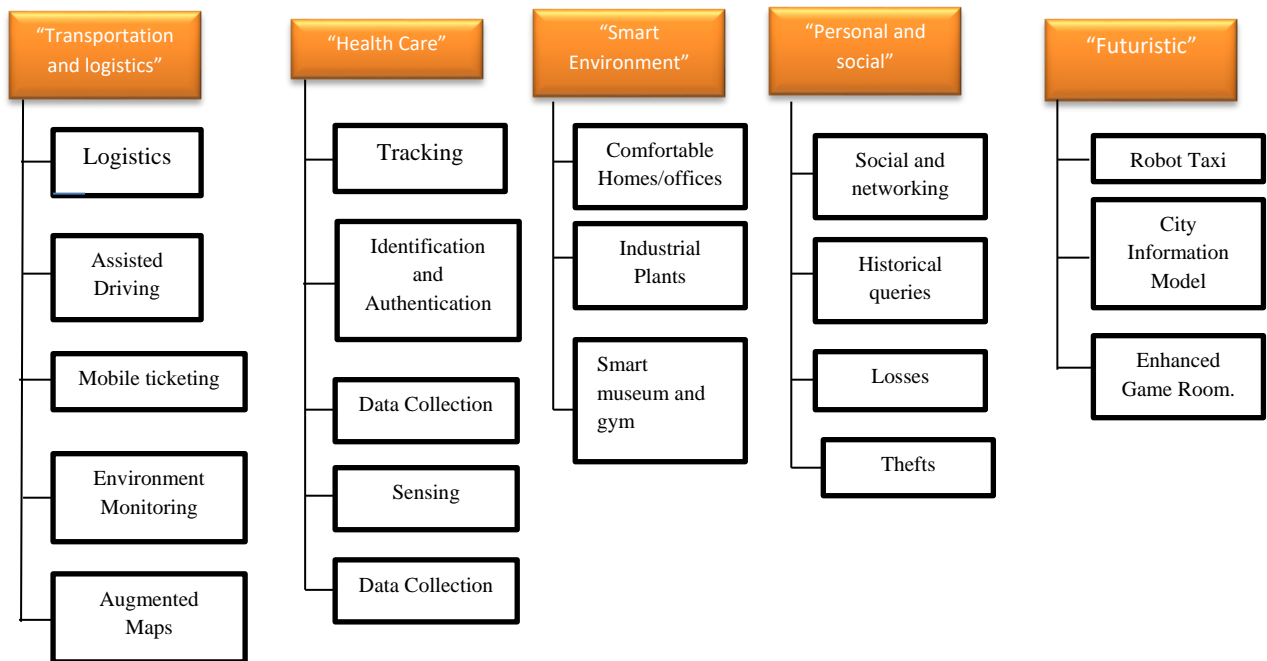

Figure.1: IoT applications in the different Domains

2. Literature Survey

Radio frequency signals have capability to carry the energy is circumvent the constraints due to the distance. In present days, energy harvesters are able to receive the energy in the range several millimetres. For instance, Intel has demonstrated the wireless charging of a temperature and humidity meter as well as a liquid-crystal display by using the signals radiated by a TV station 4 km away [8]. The novel technologies such as MIMO, Beam form design, optimal resource allocation in wireless medium are facilitate the further development the wireless powered communication (WPC). These technologies have capability to counteract the channel impair parameters like path loss, fading, interference, etc. The applications of wireless powered communication are wide in range. For instance, small sensor networks for bio-medical implants, Radio-frequency Identification (RFID), in industries for monitoring Purposes. The power signal has also occupies the certain bandwidth like the information signal. However, SWIPT protocol facilitates the transmission of both information and energy simultaneous without consuming extra bandwidth resource. In addition, the resource allocation techniques signal processing techniques are different than typical communication systems. In the following section, we mentioned the brief literature survey related to SWIPT communication systems.

SWIPT communication systems able to decode the information and energy harvesting from the received signal simultaneously. The trade-off between energy and information of the signal is the major issue and key parameter for the high Quality of Services (QoS). The trade-off between energy and information studied for different channels like flat fading channel, frequency selective channel respectively [2,3]. The three typical receivers such as Power splitting, separated, and time-switching receivers were studied [9, 10]. In particular, power splitting receiver split the received signal in two components: power and energy with certain ratio. In article [9] and [10], authors mentioned the trade-off regions for different receivers. In article [11], the authors focused mainly on the resource allocation in ergodic fading channel for point to point communication with power splitting receiver. The author, in article 12, focused on the power location algorithms and proved that introducing power-splitting receivers can improve the energy efficiency of a communication system. On the other hand, different sensevity ranges information and energy revers arises the problem of unsecured communication. The physical layer secured communications such as beam-form design was studied in [13, 16-18]. The authors in [13] and [16] are considered the potential eavesdropper, optimal beam form designs for minimizing the total transmitting power with or without channel state information respectively. In article [17], authors focused on the multi-objective framework to handle conflicting system design goals for providing communication security while guaranteeing Quality of Services (QoS) in WPT to EH receivers . Beam form design investigated for the enhancing the secrecy rate of SWIPT communication in [18]. The new technology, artificial noise strategy introduced in [17] for secured communication. The Artificial noise (AN) has capability to degrade the channel quality of potential eavesdroppers and acts as an energy source for expediting energy harvesting at the receivers.

In this article, the main work involved on the enhancing the secrecy rate in SWIPT communication systems. The proposed system problem is solved by using the convex optimization methods. Semi-definite-programming, Dual-Lagrange problem introduced for the solving the problem.

3. Background:

The power carrying capability of radio frequency-waves facilitate for charging up the small sensor networks which are non-feasible for periodic replacements. This technology is very flexible, unlike Magnetic induction where receivers should be situated at specific location [6-8]. It supports the long-distance communication than existing typical technologies like “*Induction of Magnetic*” and “*coupling due to inductive*” [6]. Radio frequency-enabled wireless powered communication has many possible advantages, such as: the long-distance transmitting range, broadcasting, less value of receive form factor [5, 7, 9]. However, due to signal degradation with longer distances, it is mainly using for the small RFID, small sensor networks. It has many other challenges, such as health hazard, distances constraint, path loss, scarcity of resources such as power, and frequency bandwidth [11]. But, the advanced technologies such as the smart antenna (*MIMO*), “*Millimeter wave communication* [13]”, Effective beam design technology [10], “*efficient power control protocols*” [10], SWIPT networks etc, facilitate the further improvement of this technology [15].

The simultaneous power and information carrying capability of SWIPT networks overcome the problem due to limited frequency resource [11]. Advance antenna technology enables for longer distance transmission of the power waveform. Most effective power allocation schemes, channel state information are really helpful to design effective beam for long distance propagation and able to focus on specific destination [10]. The novel 5G technologies such as *Millimeter wave transmission* [20], large antenna array dramatically reduces the transmission distance, path loss [18]. In present days, SWIPT became a fascinating technology as of development of low power consumption silicon chips [11]. It exploits the given frequency resources more effective way. However different sensitivity ranges of energy harvester (EH), Information decoder (ID) leads to information leakage between transmitter and receiver. In general, malicious harvesters are located close to the transmitter as of low sensitivity range [10]. Thus, the malicious receivers are decoding more efficiently than information decoders. The secrecy rate will decrease if a multiple number of malicious receivers at the transmitter [13].

4. Wireless Powered Communication Network Model:

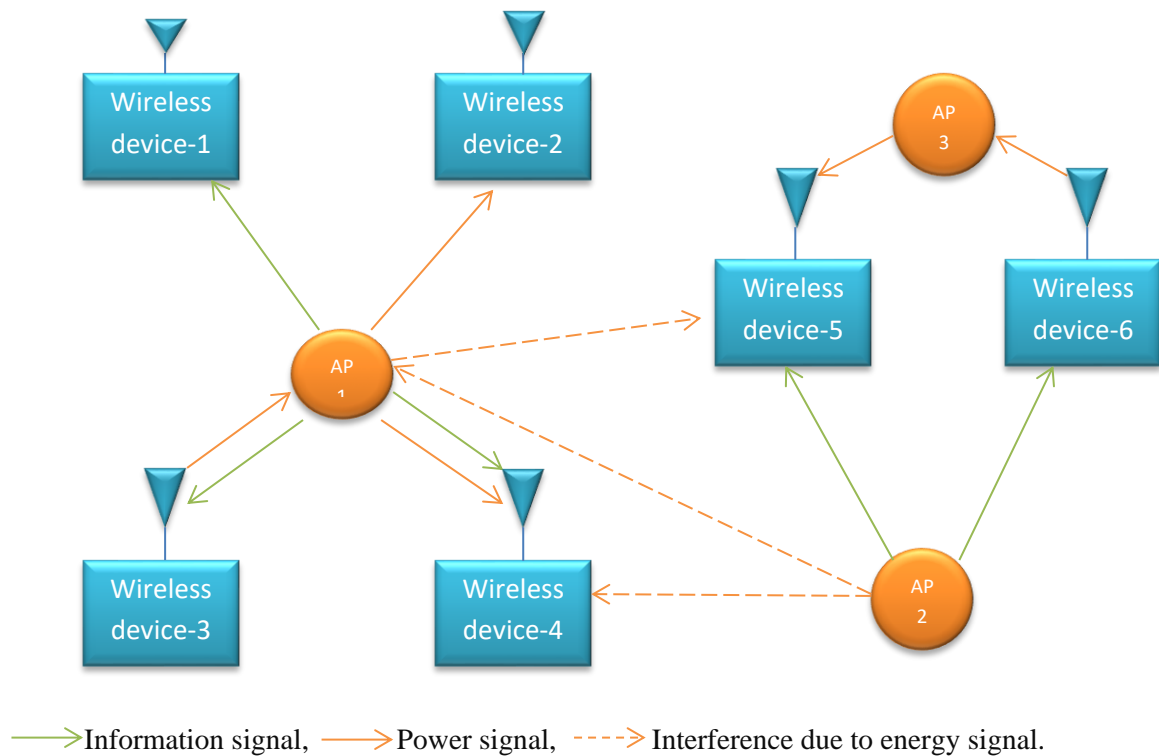

Figure 2: Wireless Powered Communication (WPC) network model

The above diagram represents the three different communication flow models of the wireless powered communication based on the link between Transmitter and Receiver

4.1 Wireless Energy Transfer: This is the one-way communication from the transmitter to the Receiver. This scheme acts like a Duplex communication (only one-way communication). For instance, access point 1 (AP1) to wireless device-1 and access point 2 to wireless device-5.

4.2 Simultaneous Wireless Information and Power Transfer: This scheme is also known as the integrated SWIPT. In this scheme, transmit the combination of both information and power to the destination through the downlink.

4.3 Wireless Powered communication networks: This scheme is the sub-class of SWIPT energy transfer in the down-link and information transfer in the up-link, e.g., the Access point (AP1) to Wireless Device-3. This scheme is also known as closed loop SWIPT.

5. Simultaneous Wireless Information and Power Transfer:

In WPC communication, power signal also occupies the bandwidth like an information signal [18]. So, in order to mitigate the interference, we exploit the typical orthogonal frequencies but this procedure is not only spectral inefficiency but also consumes the communication resources. However, a novel scheme called SWIPT is enabling the simultaneous transmission of both information and energy of the signal [11]-[13]. So, we have to consider the trade-off between energy and information and this trade-off is relying on the various factors [12] (e.g. Channel information, etc.). An efficient SWIPT scheme involves a rate-energy trade-off in both the transmitter and receiver designs to balance the information decoding (ID) and energy harvesting (EH) performance [11]-[13]. In addition, signal processing at the receiver side depends on the type of receiver. In the WPC, four typical techniques for recovering the both energy and information signal at the receiver side [11] – [13]; Time Switching Receiver, Power Splitting Receiver, Antenna Switching, Spatial Switching.

5.1 SWIPT Communication System Models

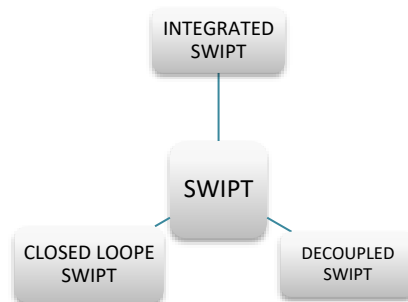

Figure 3: Different types of SWIPT communication

5.1.1 Integrated-SWIPT: In this scenario, both the information and power transmitted in the same modulated wave form [11, 12, and 13]. However, this scheme is constrained by the distance. Since, the transmitted range of power is less than information signal. Thus, this model is rely on the distance and operated only for the limited distances.

5.1.2 Decoupled SWIPT: This scheme introduces a new station called Power Beacon. It is transmitting the Power signal to the energy harvesters. This scheme avoids the Problem in integrated SWIPT. However, it creates the problem at receiver side as inference problem between these two signals. In order to avoid this problem, both Power Beacons and Information Transmitters use the orthogonal carrier frequencies (f_c). So, we call this scheme as the decoupled SWIPT [17].

5.1.3 Closed-Loop SWIPT: In this scheme, receiver gets the power from the base station and receiver exploits this power for transmitting back to base Station. However, both uplink and down link incur the double attenuation [12, 17].

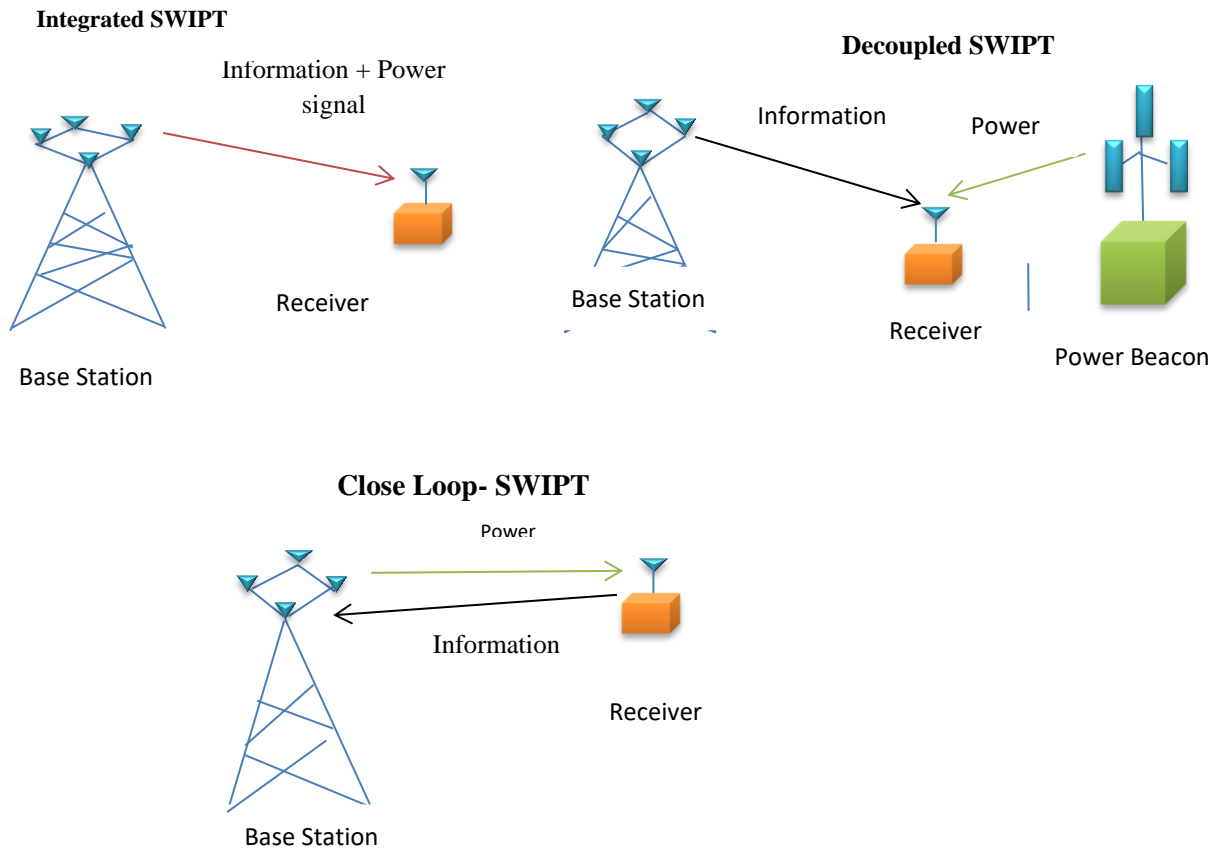

Figure 4: Different modes of SWIPT system based on the link

6. Physical layer Techniques of SWIPT

6.1 Energy Beamforming: Antenna array provides the both power gain as well as sharp beam forming to focus the transmit power in a specific destination [8, 9, 10, 43, 44, 52, 53, 81]. The beam form can be formed by the array of antenna elements are arranged with separation of half wave length. The distance between the antennas are should not exceed the half wavelength due to “grating lobes” (multiple beams) form along with the main lobe [8]. The functionality of efficient beam form is to combine coherently at a specific receiver but destructively cancels at others. The sharpness of the beam can be improved by either increasing the number of antennas at the transmitter side or increasing the carrier frequency [13]



Figure 5: Beamforming with multi-antenna at the transmitter side.

Furthermore, the energy of beam forming directly related to the wireless mechanism called “scattering” [14]. Scattering can disperse the power of the beam and cause the power degradation dramatically. So, the power-transfer channel refers to one over free space [14].

The Propagation loss of the energy beam depend on the

1. Transmitter and Receiver arrays, denoted as the A_t and A_r respectively.
2. Wavelength of the transmit beam.
3. The propagation distance between the transmitter and receiver.

The beam efficiency of the Microwave Power efficiency depends on the Product of three factors:

1. The conversion efficiency of Direct Current to Alternating Current (DC-AC).
2. *Beam efficiency*: which is the ratio between received to transmitted Power
3. The conversion efficiency of Alternating Current to Direct Current (AC-DC).

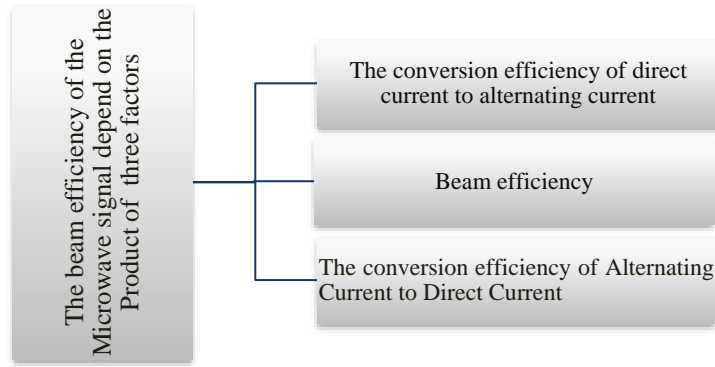

Figure 6: The beam efficiency of the power beam and it's dependency parameters factors

6.2 Wireless Channel and Resource Allocation in SWIPT Systems

6.2.1 Conditions for Efficient WPT:

The total available power density at receiver antenna is given by Friis-free space equation [17]

$$P_R = \cos^2 \phi \frac{P_T G_T}{4\pi R^2} A_e \quad (2)$$

where P_T , and P_R are the transmitted and received power respectively. $A_e = \frac{\lambda^2 G_R}{4\pi}$ is the antenna parameter called effective area for reception. G_t , and G_r are the gain of the transmitter and receiver antenna respectively. λ denotes the wave length of the radiation, $\cos\phi$ is the polarization loss factor and gives the information of misalignment (angle ϕ) of the received electric intensity vector E and the receiver antenna linear polarization vector. Thus, from equation 2, we can deduce that high antenna gains, and must be aligned with the received E-field ($\phi=0$). However, we can't achieve the above stated conditions due to random nature of the channel. For instance, rayleigh channel, it has both fading and uniform distribution ($-\pi \leq \phi \leq \pi$). Thus, rayleigh multipath propagation environment the received signal has random polarization. Furthermore, Friis free space is frequency dependent, besides, total received power is calculated by integrating the received power P_R over frequency [17]. Thus, we could acquire a more power by wideband antennas or multi-band antennas.

6.2.2 Channel State Information: Channel state information at the transmitter (CSIT) side really helpful to design an efficient energy beam form [12, 72, 73, 77]. Yet, it really difficult to acquire exact state information due to the random nature of the channel. Furthermore, energy receivers have no signal processing techniques to perform the channel estimation [15]. Channel accurate estimation procedures at transmitter side consume time and energy significantly. This can be the offset for the energy gained obtained from a refined EB. There are few cases related to hardness of the channel acquisition and they are; (i) acquiring the channel state information from malicious receivers because the external eavesdropper is usually passive in nature and well-hidden [16]. (ii) Mobility of the receiver really huge impact on the channel state information due to time-varying nature of the channel [13]. (iii)

The received channel state information from the receiver may not be accurate as the channel is random in nature [46]. Indeed, channel information varies dramatically with receiver mobility [11].

Distributed antenna, which is the antenna based technique, to mitigate the problem due to channel state information [16, 62, 63]. Here, receiver harvests the energy from a small subset of nearby transmitting antennas. So, it is significantly reduces the amount of feedback signal for channel estimation. However, we need an effective coordination to tackle this system.

6.2.3 Resource Allocation for Systems with SWIPT: In wireless communication, resources (e.g. bandwidth, power) are limited for the communication. So, we need optimal resource allocation techniques for improving the quality of services. Furthermore, the conventional QoS requirements such as throughput, reliability, energy efficiency, fairness, and delay, the efficient transfer of energy plays an important role in SWIPT systems [18, 50, 51].

6.2.4 Joint power control and user scheduling: SWIPT scheme exploits the RF as a carrier for both energy and information to destinations. However, the sensitivity ranges are different for the energy receiver and information decoding receiver. This is actually an obstacle to realizing the SWIPT. So, joint power control and user scheduling is the good solution and facilitating the SWIPT. For instance, if idle user channel has high gain, then we can schedule the power transfer to it to increase its life time. Optimal power allocation scheme exploits the channel state information and improve the performance of the system with given power resources. Let we consider N_t antennas at the transmitter side, and one single receiver antenna along with K energy harvesting receivers. In this system, with optimal power control technique, the trade-off region can improved by the increasing the number of antennas N_t , and the averaging harvesting can be increased by the increasing the K number (number of energy harvesters).

6.2.5 Energy and information scheduling: Consider the passive receivers with energy transmitter in the communication system. In this case, passive devices acquire the energy from the transmitter then this energy exploit for the transmitting the information to the transmitter. In this scenario, transmitter has to wait for energy at the same time need some time to transmit the information content towards the destination. This protocol also known as “Harvest then transmits [11]. If we allocate more time to transmit the energy to receiver for energy harvesting, which could use for uplink for data transmission. However, at the same time, we have low data rate towards the destination. Thus we need an optimal time varying scheme to enhance the data rate, the system throughput.

7. Antenna Structure for the Energy Harvesters:

Antenna structure at the energy harvester is the critical component in Wireless Powered Communication [17]. The designing of the antenna is more critical challenge for engineers. Rectennas, in general, we uses in the energy harvesters. These antennas comprises of both rectifier for radio frequency to direct current and antenna for the reception of the signal. In Practice, it can achieve 100% energy conversion efficiency [18]. However, this conversion efficiency depend on both P_R , and R_{DC} . Where P_R is the input power level of the rectifier and R_{DC} load resistance. Finally, energy receivers comprises of the one diode of single shunt full-wave rectifying circuit with a capacitor to reduce the loss in diode, $\frac{\lambda}{4}$ distributed line. In general, we prefer to use the -diodes. As, they have features such as low forward voltage and facilitates the fast switching. Low forward voltage is the essential because sometimes input RF power may be small so fast switching is needed to follow the relatively high RF frequency of the received signal [17]. On the other hand, we can use the CMOS circuit technology. Yet, they are very sensitive to forward voltage.

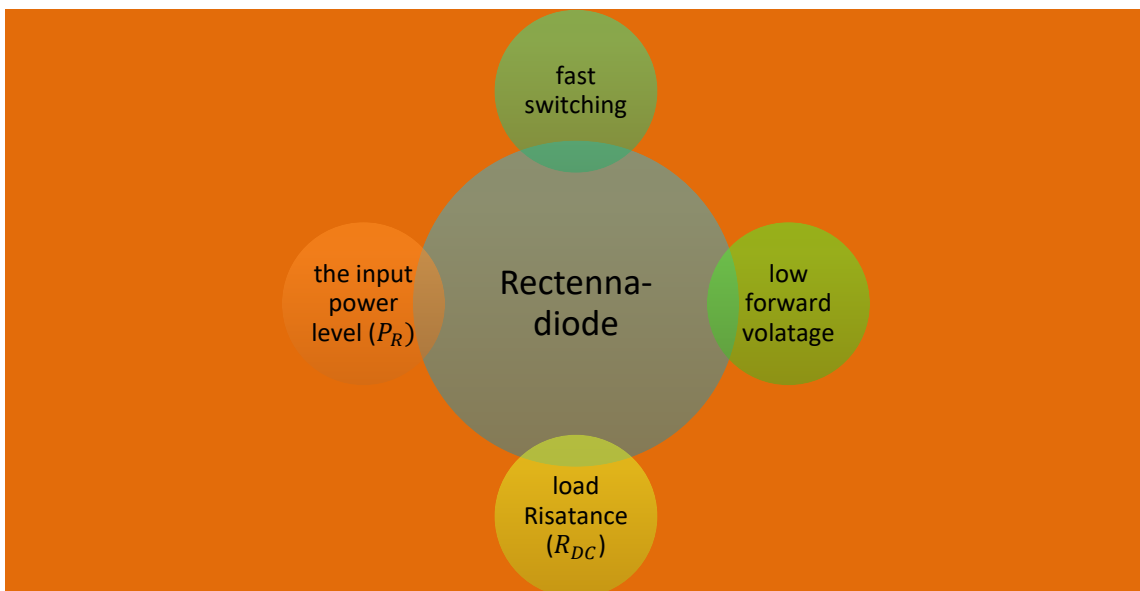

Figure 7:Rectenna-diode and their dependency on various Parameters

8. Receiver Structures for Wireless Powered Communication

8.1 Time Switching: This is the switching based circuit and switches the time between information decoding and energy harvesting. In this circuit, the entire power used for either energy harvesting or information decoding based on length of switching time [20]. This technique is enabling the simple receiver architecture. However, time synchronization is the main problem. The trade-off between energy and information could be achieved by varying the switching time duration.

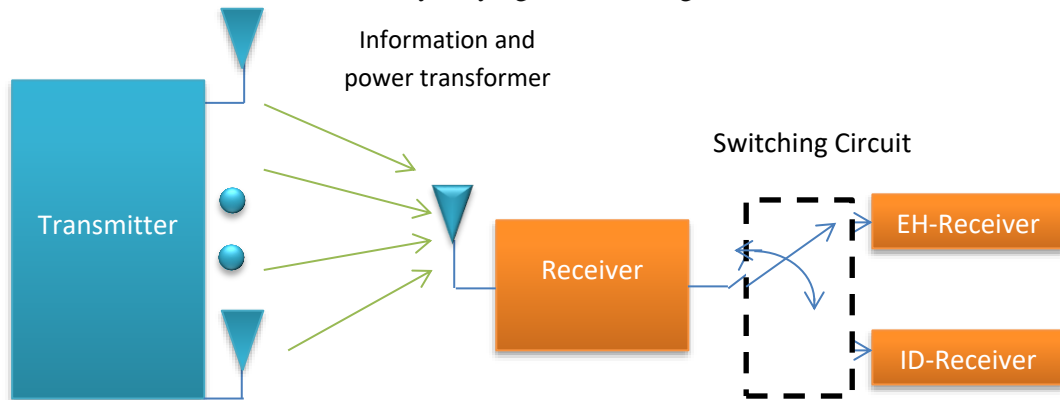

Figure 8: Rectenna-diode and their dependency on various Parameters

8.2 Power Splitting: This receiver structure uses the passive power splitter for splitting the received power for the energy and information receivers. The splitting ratios depend on the factor ρ (In general, it lies over $0 \leq \rho \leq 1$), which is also known as splitting ratio [20]. Furthermore, the trade-off could be achieved by varying the splitting factor. Power Splitting receiver is the special case of the time switching circuit. For instance, when $\rho=0$, energy receiver harvests the power and when $\rho=1$, it acts as the information decoding circuit.

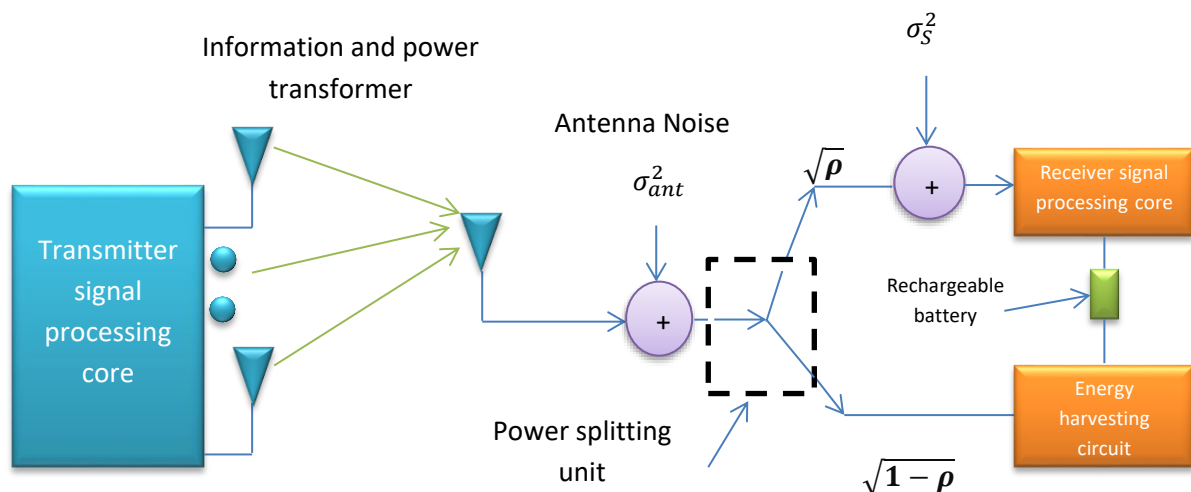

Figure 9: Wireless information and energy Transformation with power splitting receiver

8.3 Spatial Switching: Multi Input and Multi Output (MIMO) technology with Singular Value Decomposition (SVD) splits the channel into the parallel- eigen-channels [20]. Each parallel channel conveys either information or energy. At the output of each Eigen channel, there is a switch that drives the channel output to either the conventional decoding circuit or the rectification circuit [21]. Eigen-channel assignment and power allocation in different Eigen-channels is a difficult nonlinear combinatorial optimization problem [22]

8.4 Antenna Switching: This technique exploits the multiple antennas at both transmitter and receiver side [23]. It enables the SWIPT by the simple switching circuit. For instance, consider N_R received antennas then this circuit exploits the sub of N_R for the decoding, and remaining receivers for the energy harvesting. This technique is most feasible solution for the SWIPT and easy to implement compare to other techniques like the time switching and power splitting receivers [24].

8.5 The Range of the wireless communication for the Mobile devices: In this scheme, both resources namely: Wireless power and information efficiency calculations are different. The powered signal efficiency depends on the amount received power at the receiver side [24]. On the other hand, information signal efficiency relies on the signal to noise ratio [24]. In general, the received power falls in the rang of the -100dBm to -50dBm as the noise level is low (which is in the order of the -50dbm) [25]. This range is extremely low than energy consumption of the mobile devices. So, we can accept short range for power transfer than information transfer.

Mobile Device	“ Power range”
“Wireless signals”	-120 to -50dBm
“ZigBee devices or sensors”	1 to 100 mW
“Smartphones”	19 mW to 1.3 W
“Tablet computers”	1 W to 11 W
“Laptop computers”	19 W to 52 W

Table.1: Represents the different mobile devices and their corresponding Power Ranges

Mobile Device	Power=10 Watt	Power=30 Watt	Power=50 Watt	Power=100Watt
“ZigBee/Sensor”	5.5(meter)	9.0(meter)	11(meter)	14.5(meter)
“Smart Phones”	5.5(meter)	7.5(meter)	10(meter)	14.0(meter)
“Tablet Computers”	3.0(meter)	7.0(meter)	9.5(meter)	13.5(meter)
“Laptop Computers”	0.0(meter)	0.0(meter)	3.9(meter)	7.0(meter)

Table.2: Different mobile devices and their corresponding Power Ranges

9. Research and Design Challenges

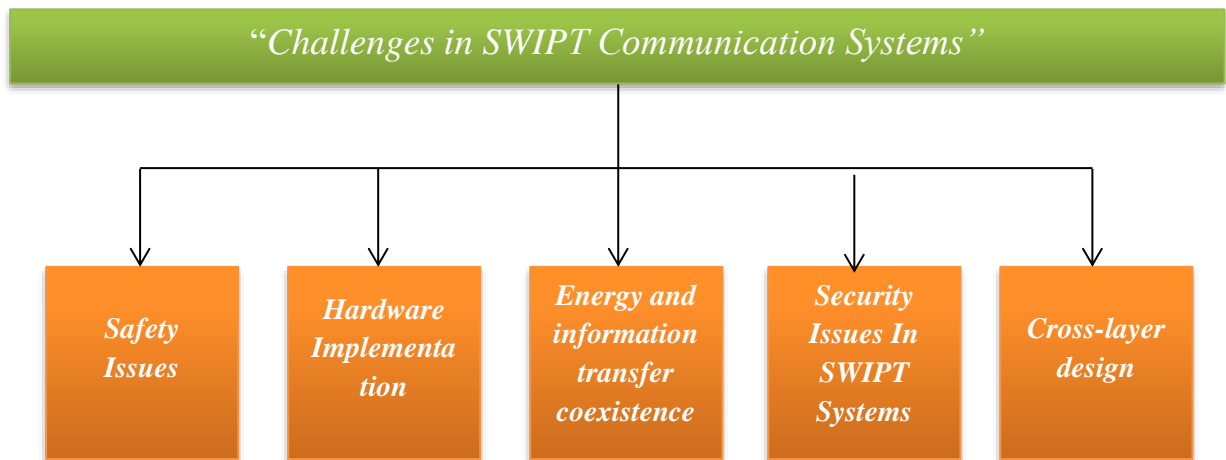

Figure 10: Challenges in SWIPT communication systems

9.1 Safety Issues: MIMO technology is the good approach for mitigating the Path loss and Interference [39, 43, 58]. However, the using of the Massive MIMO systems can cause the severe harm for human beings as the most of the power of beam accumulate at the particular area. In general, every wireless device must satisfy the equivalent Isotropic radiated power (EIRP) requirement on its operating frequency band [32]. However, we can overcome this problem by using the distributed antenna Systems. In this system, every antenna is omnidirectional and more constructive at specific location and destructive almost everywhere and intelligent coordination must require for achieving this requirements.

“According to international safety standards set by authorities such as FCC and ICNIRP [26]”. For half- Hour, The person should not intercept with signal with average Power density above $10(W/m^2)$.

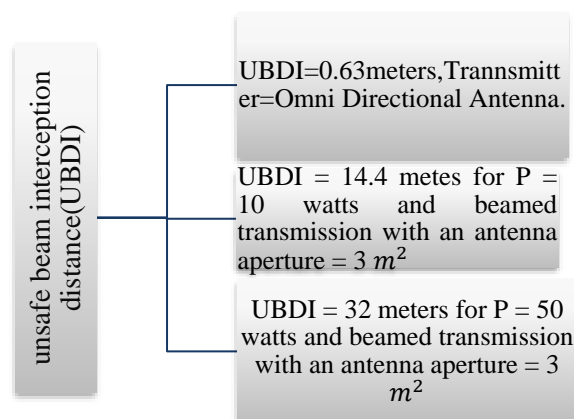

Figure 11: Different ranges of UMDI for different number of Antennas

Furthermore, the sharpness of the beam keep on decrease due to radiated nature of the power. From above diagram, we can see that the Omni directional antennas have less effect than other two schemes with given power. However, beam forming with multiple antennas have high UBDI value due to high concentration with high transmission range [26]. Thus, the number antennas increases, the UBDI value also keep on increase. So, we need an intelligent beam control technique to avoid this problem [27].

9.2 Hardware Implementation: The new advanced techniques like MIMO, effective beam designing, mille-meter wave, distributed antennas systems, etc. are completely in theatrical in nature [33].So, we need many test applications for above mentioned techniques to realize the communication scheme. There is much need of enhanced circuit designs technology for making the “off-the-shelf energy harvesting and communication modules” [31]. The most suitable prototype needed for quantify the feasibility of WPC.

9.3 Energy and information transfer coexistence: In Wireless Communication, power and bandwidth are the resources for the communication systems. In SWIPT systems, the co-existence of information and power create a many problems.

1. One way interference from the energy source to the communication network.
2. The sensitivities are different for both receivers namely: energy, Information receiver. This leads to many problems like information leakage (due to eavesdropper).

However, we can mitigate the above Problem-1 by using the advanced technologies like cognitive technology. This technology can use for effective spectrum sensing to minimize the interference from WET to communication networks.

9.4 Energy and information transfer coexistence: In General, SWIPT scheme is broadcast in nature [11]. Energy harvesting receivers can also receive the information along with power. Thus, malicious harvesting receivers can also decode the information [28]. Furthermore, in general, power harvesting receivers are located near to transmitter. So, the malicious receivers can decode more efficiently than actual information receivers due to more power availability.

9.5 Cross-layer design: Medium Access Control (MAC) plays an important role for quantifying the fairness and efficiency of the given system. In general, cross layer design is the optimal for wireless systems especially the cross relation between MAC and Physical layers. The WPC scenario, the cross relation between MAC and Physical layer has many advantages.

10. Security Issues in SWIPT Communication: Security is the main problem in SWIPT communication due to the broadcast nature of wireless channels. In SWIPT communication, energy receiver also receives the information signal. Some energy receivers have capability to decode the information with more efficiently like information receivers. This type of unintended receivers called eavesdroppers. From the physical layer perspective, secure communication achieved by the directing the information signal toward the legitimate receiver and impair the channel of the energy receiver simultaneously. However, In SWIPT communication systems, transmitting power, information transmission security are the important parameters. This dual objective problem leads bring the new challenges to design the physical layer security in the SWIPT systems. Explicitly, power, information competes to each other for limited bandwidth resources. In the following section, we introduced the different SWIPT systems.

10.1 SWIPT in Broadcasting Channels: In SWIPT communication, transmitter broadcast the both information and power energy to the receivers. However, the energy harvesters are also receive the information signal. If the energy receivers are potential eavesdropper, eavesdropping of information take a place [78]. In this scenario, the PHY-security challenges mainly in three folds.

10.1.1 Different sensitivity ranges of receivers: In general, information and power receivers have different sensitivity ranges. The minimum sensitivity requirement for the information receiver is -60dBm . On the other hand, minimum requirement for the power receiver is -10dBm [72]. Due to this difference, energy receivers are located near to the transmitter than information receivers. In addition, power signals are distance dependent and decrease radially. Thus, the received signals at the information receiver are less strong than potential eavesdropper resulting high information interception.

10.1.2 Cooperative eavesdropping: In SWIPT communication, energy receivers can be the potential eavesdroppers. So, it is impossible to impair the signal at the eavesdroppers because to fulfil the requirement of the energy harvesting. Thus, the joint detection of the information takes a place at both information and eavesdroppers. However, the quality of intercepted signal at the much higher than information receiver, lead to information leakage in the communication system.

10.1.3 Inter-user interference: The transmitter, in SWIPT, broadcasts multiple information and power signals at a time. Then, the information receiver suffers strong interference due to the undesired information as well as power signals. The conventional interference management schemes can mitigate the interference but they may lead to weak RF powered signals at the power receiver end. Thus, typical interference management schemes not suitable for the SWIPT communication systems. On the other hand, channel state information CSI of power receivers is relay helpful for both secured communication and high Quality of Service (QoS) of energy harvesting at the energy receivers.

10.2 SWIPT protocol in Relaying systems: This method shortens the transmission distance and provides the diversity gain in wireless communication. It is the optimal approach in the wireless communication. This method is suitable for the improving the performance SWIPT communication. In this method, two fundamental modes for transmission. In first mode, passive relay split the received signal into the power and information signal components and one for the information receiver and other for the energy harvesters. In second mode, relay use the energy signal for harvesting and send the information signal to the receiver. However, for both relaying modes, many challenges exist.

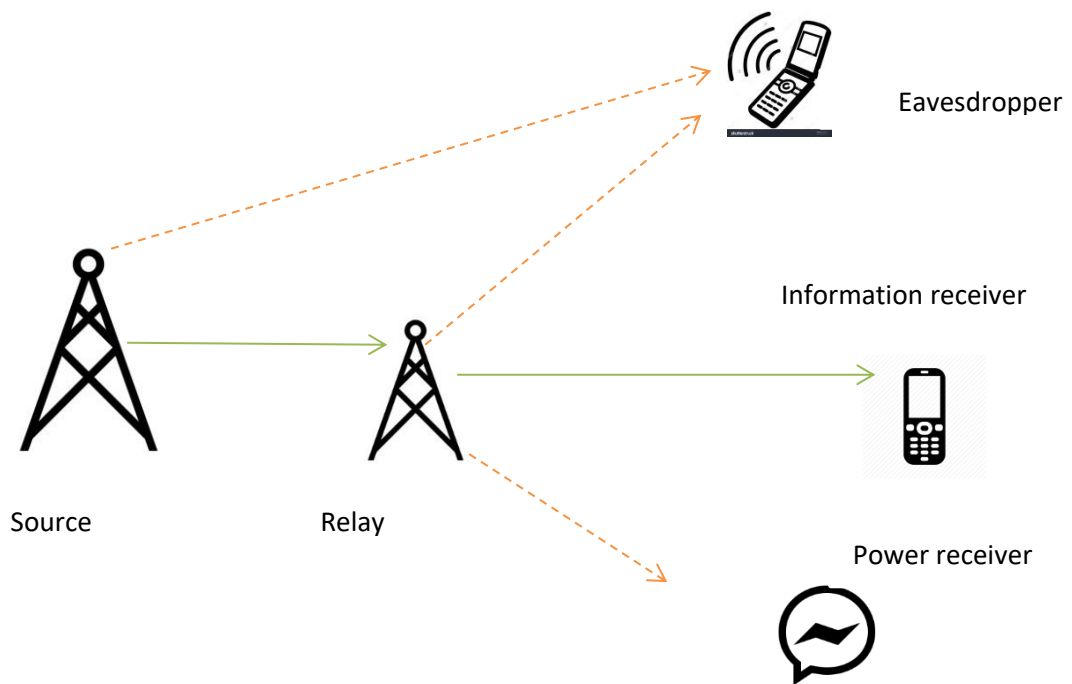

Figure 12: Relay based Communication in SWIPT

10.2.1 Untrusted Relay: Relay node can be the potential receiver. In self-power mode, malicious relay can use the energy signal for decoding the information [70]. In second case relay node can corrupt the information signal with power signal. Thus, lessen the quality information at the information receiver.

10.2.2 Unsecured Transmission: Cooperative relay transmission scheme exploits the two orthogonal time slots for the information transmission to the receiver end. So, external eavesdroppers have the chance to sense those two copies of the Information power. The eavesdropper may perform the maximum ratio combining (MRC) and get the optimal signal than information receiver (IR). In fact, In SWIPT network model, eavesdroppers are situated neat to transmitter so they have high probability to get better information power than legitimated receiver (i.e. Information Receiver (IR)). However, we have optimal physical layer strategies to mitigate the security issues. This scheme can facilitate to

perform the multiple-relay-cooperative-transmission. The relays can cooperative with each other to create a virtual multiple-input multiple-output (MIMO). For instance, some relays can share their antennas to transmit information beamforming to a legitimate information receiver (IR), while the others can adopt power beam forming to transfer wireless power to the power receivers.

10.3 SWIPT Protocol in Interference Networks: In interference communication networks, both the information and power transmitter use the same channel. In this scenario, energy harvesters can able to receive the all transmitted signal and harvest the high amount of energy. However, the combination of both the information and power can cause the high co-channel interference at the information receivers and this lead to the low SINR and high probability of information leakage. In the following section, we discussed about the challenges in the interference networks.

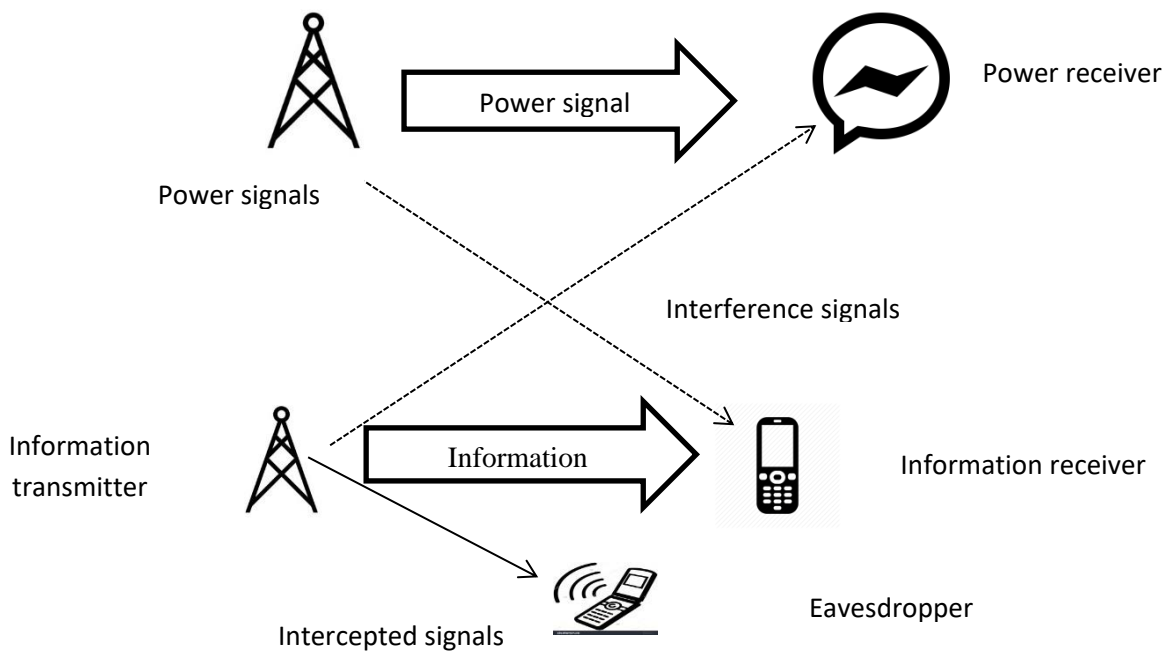

Figure 13: SWIPT Protocol in Interference Communication

10.3.1 Uncoordinated Transmission: Coordination of both power and information are the important task to decrease the interference. However, from figure.13. Both information and power transmitter are geographically separated. So, it is hard to exchange the information and coordination of transmission between each other.

10.3.2 Unavailability of channel state information (CSI): The signal processing of energy harvesters are completely different from the information receivers. In other words, power receivers do not equipped with the baseband signal processing unit. So, the power receivers are not able to feed back the

instantaneous channel information to the transmitter. The feedback of CSI from the information receivers may not be suitable for secure schemes.

10.3.3 Conflicting objectives: Interference communication is beneficial for the energy harvesters. As, they can able to harvest the high amount energy. The mitigation of interferences in SWIPT communication can improve the secrecy rate. However, Power receivers may not receive the enough energy for harvesting the power.

10.4 SWIPT in Wireless Powered Communication Networks: In this scenario, power receivers harvest the energy from the power transmitters to send the information to the information receivers as shown in the fig.4. In addition, it is the practical network application in the implanted medical devices.

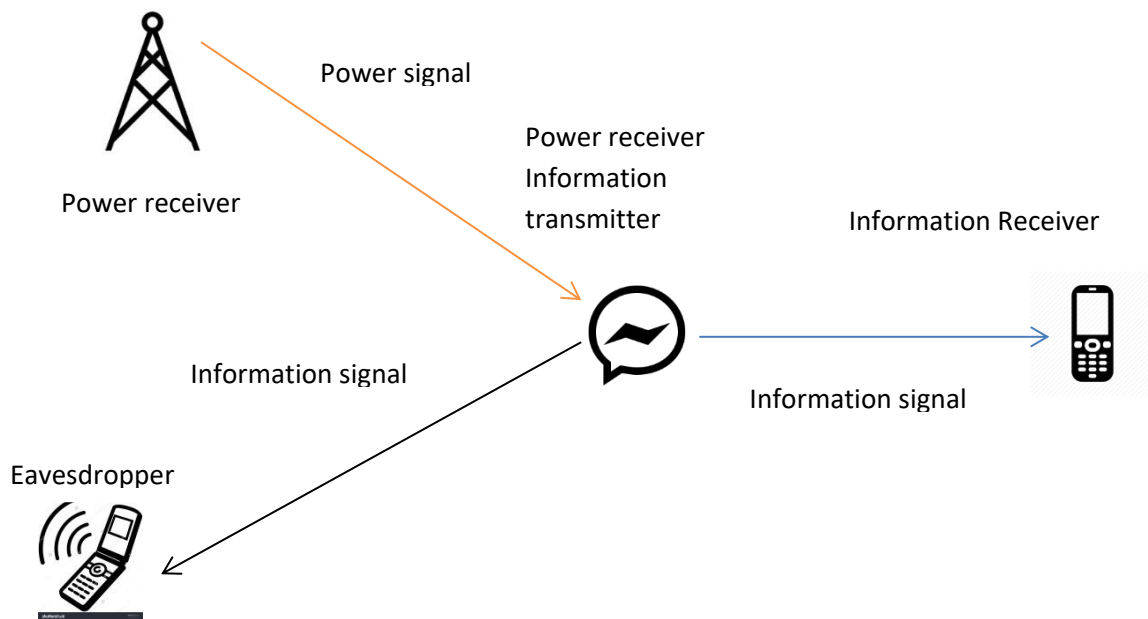

Figure 14: SWIPT Protocol in Wireless Powered Communication

10.4.1 Difficulty in performing joint resource allocation: In SWIPT communication protocol, both the information and power transmitted concurrently. The harvested power at a power receiver (also as an information transmitter) affects the performance of information transmission directly. If consider the PHY-security strategies, secrecy rate is not increase with the transmitting power resource. Thus, not necessary to allocate the resources for the information and power transmitters. For instance, if we consider the typical time division strategy for the transmission, the first sub-time slot used for the information and second slot used for the power transmission. However, the optimization of these problem is non-convex optimization problem, and not facilitates the optimum design of circuits.

10.4.2 Weak anti-eavesdropper capability: In SWIPT communication networks, information transmitter has acquired power by harvesting RF energy. So, there is limited power available for

information transmission. In that scenario, the optimum anti-eavesdropper schemes not suitable for the information transmitter. For instance, if the power of artificial noise is too low then it not effectively interferes with the eavesdropper. Finally, in SWIPT communication networks, resource allocation and anti-eavesdropping at the power transmitter is the optimal approach.

10.5 SWIPT protocol in Cognitive Radio Networks (CRN): SWIPT protocol in cognitive radio networks has received great attention. In this scheme, secondary transmitter broadcast the both information and energy over a given Authorised spectrum of primary network. As shown in fig.?. However, many research challenges and problems exist to realize these networks.

10.5.1 Open Architecture: Cognitive radio architecture is open and dynamic in nature. So, the possibility of various unknown receivers is allowed to use the licensed spectrum. This is the most vulnerable to eavesdropping as a power receiver, as a potential eavesdropper might obtain more knowledge of information transmitter due to the signal exchanges during cooperative spectrum sensing.

10.5.2 Restricted secure scheme: There is a limited freedom to access the given bandwidth in order to comply the pre-condition for the spectrum access. In addition, allocation of the extra power resource to the signal can cause the high interference problem.

10.5.3 Interference management: Both primary and secondary transmitter work on same give spectrum. So, received signal at the final receiver my face high interference problem. Thus, low quality of received signal along with low secrecy rate.

SWIPT protocol in Cognitive Radio networks (CRN) has many optimal opportunities for cooperative communications between the primary and secondary systems at both the information and power harvesting levels. In particular, the secondary transmitter can transmit both secret information and power signals to the secondary receivers, while it charges energy limited primary receivers wirelessly, in exchange of utilizing the licensed spectrum. This approach gives more incentives for both systems to cooperate and therefore enhance the overall system performance.

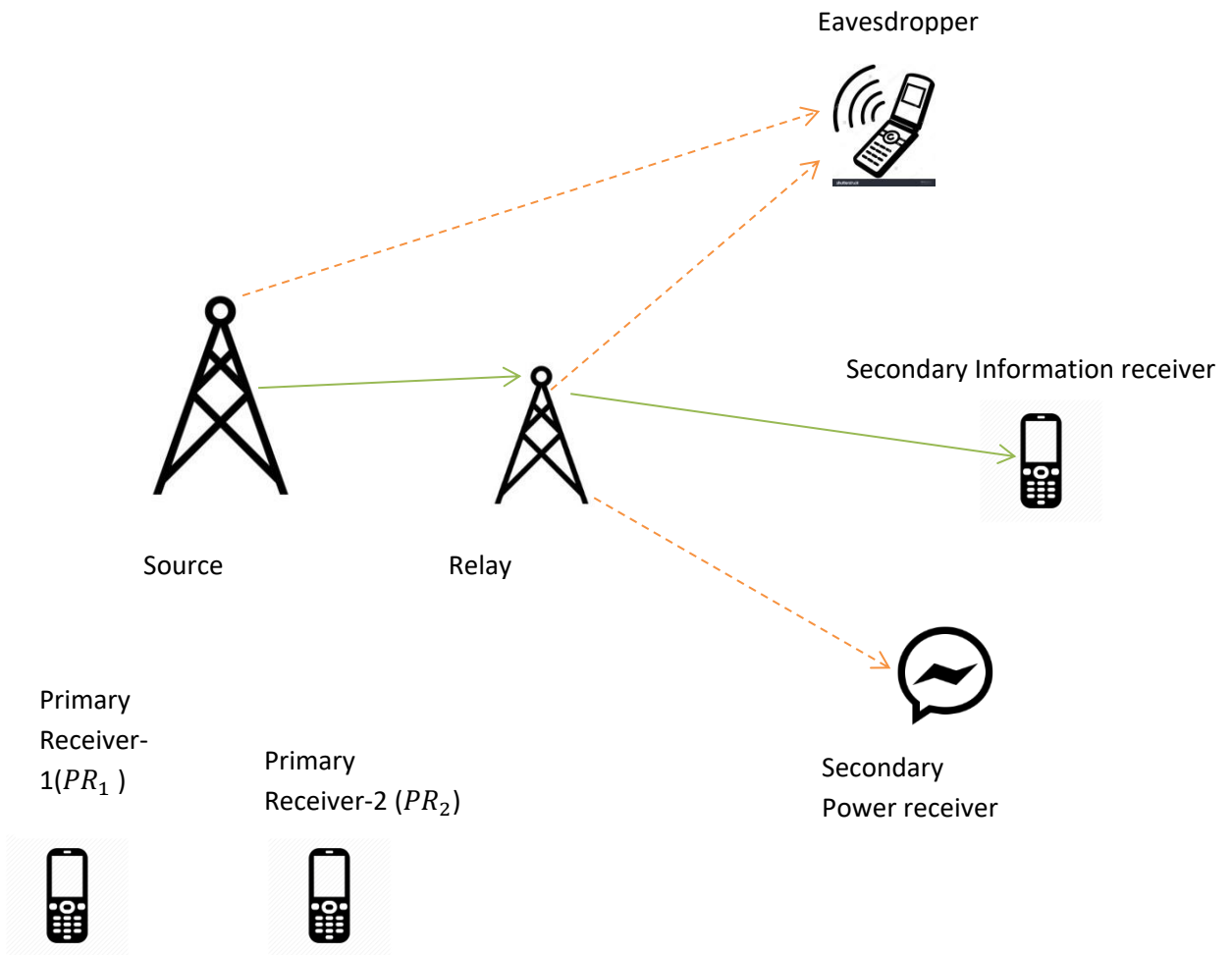

Figure 15: SWIPT Protocol Cognitive Radio Network

11. Physical layer Techniques for Security issues in SWIPT systems: In the following section, we discussed about the various possible techniques for mitigation of the security issues in SWIPT systems.

11.1 Multiple Antennas at the Transmitter side: Multiple antennas at the transmitter side can facilitate the beam forming by transmitting the same information with more antennas [23]. This technique can focus the beam form at the null space of the eavesdropper’s channel so that it can’t hear the signal [28, 39, 46, 52, 54, 60, 64, 82]. The designing of the beam shaping and channel state information at transmitter are important Parameters. The sharpness of beam depends on the number antennas at the transmitter side [13, 38]. More transmitting antennas lead to high sharpness and can focus at specific location without causing the interference. So, we can mitigate the problem due to interference of eavesdroppers. Furthermore, we can use the power signal to confuse

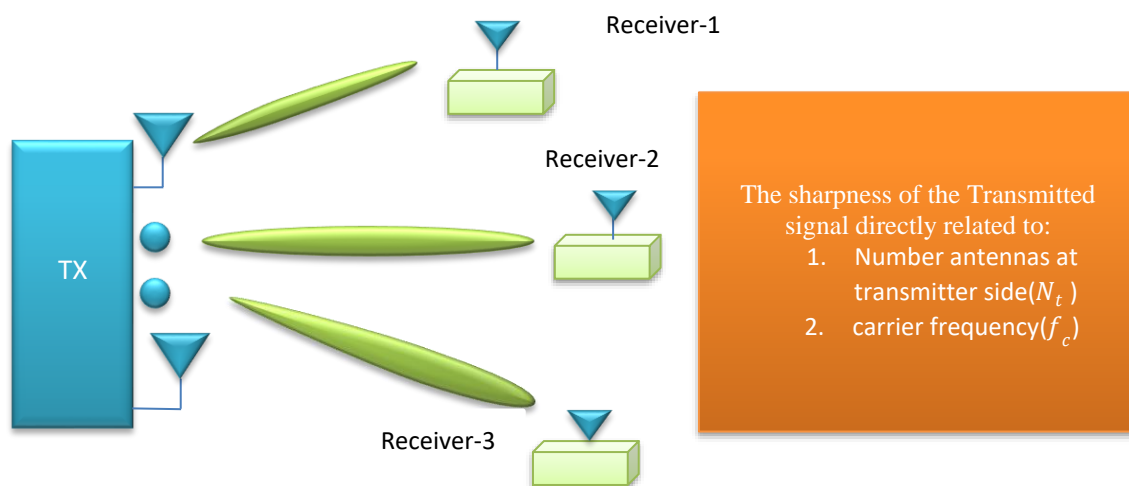

Figure 16: Beam forming in “MIMO” system

the malicious receivers without failing at requirement of the power receivers by suitably adjusting the beam form so we can enhance the secrecy rate at the same time enhance the data transmission (spectral efficiency)

[28].

11.2 Artificial Noise: Secrecy rate is the difference between the information receiver capacity and rate of capacity of eavesdropper [29, 61, 56, 67]. So, we can achieve the optimum secrecy rate if we impair the channel between malicious receiver and transmitter. This idea leads to new noise technique called Artificial Noise (AN) [30]. In SWIPT scenario, we transmit the information signal, power signal along with this noise. Due to power constrain, we use the power signal as the noise signal [30,70].

However, we have to consider the few possibilities while transmission. The artificial noise can interfere and degrade the information transmission channel. So, the channel state information is key

thing to counteract this problem. If we have perfect channel information of the receiver, we can transmit the signal in null space without causing the interference to information signal. Yet, if we do not have enough information, then artificial noise could leak in to main information signal and degrade the decoding performance of the receiver [29]. Thus, channel state Information and direction of noise play a vital role for the optimum performance of the system.

On the other hand, artificial noise can act as the energy resource for the Energy harvesters. So, the design of artificial noise has to reach the two objectives: one is to impair the channel between eavesdroppers and transmitter. Second objective is the efficient energy transmission from transmitter to power harvesters [28]. So, designing of the artificial noise has to maintain the optimal trade-off between confusing the malicious receivers and improving the amount of harvested power at the power receivers.

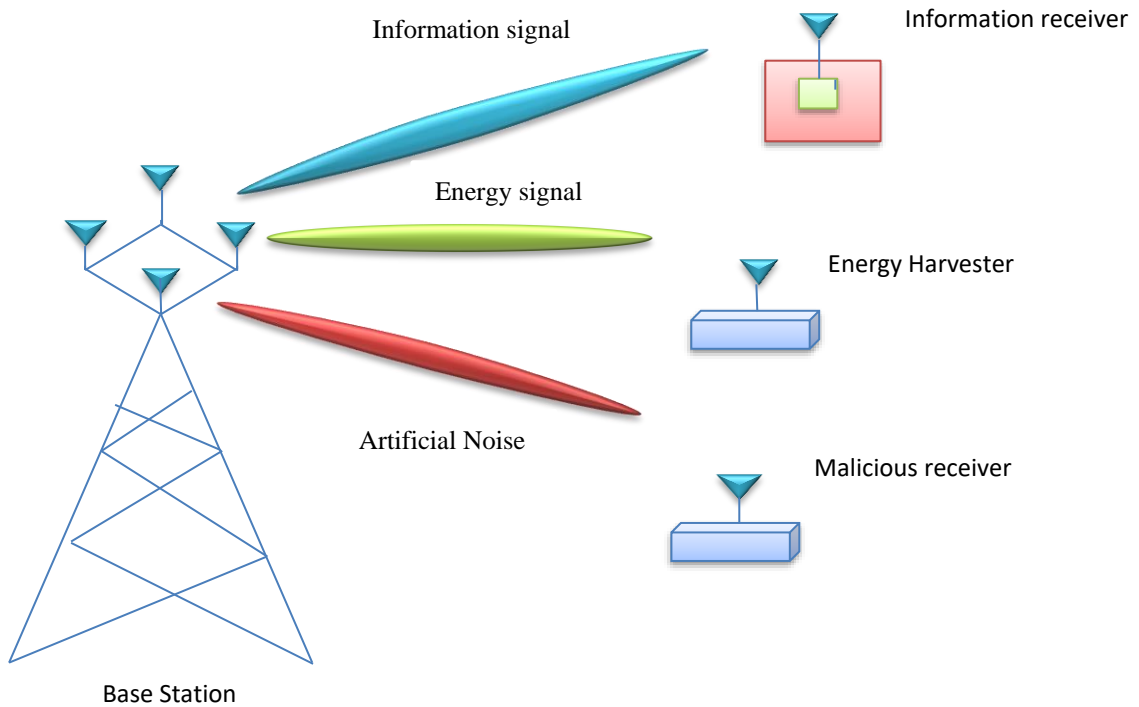

Figure 17: Beam forming in SWIPT system.

11.3 Resource allocation: In SWIPT communication system, resources such as bandwidth, power are the important constraints. So, the optimum performance of the system depends on the resource allocation with given limited resources [13]. However, many resource allocation techniques are rely on the channel state information. Thus, acquiring the channel information is an important task. Furthermore, conventional algorithms are not suitable methods for the SWIPT systems as of the two

different kinds of the receivers [31, 53, 57, 59]. Finally, resources allocation techniques are really useful if we have enough channel state information at the transmitter side.

11.4 Relay Selection: SWIPT can increase the range of the transmission with less outage probability by using the relay technique. Thus, we can combat the problem due to path loss. SWIPT systems can use this technique in various scenarios [65]. Basically, SWIPT technique has two types' relays; one is passive relay, other one is the active relay. In SWIPT scenario, multiple-relay cooperation is the optimal technique as the information, malicious receivers, and power receivers are physically separated. Finally, relay selection is the optimal approach. However, in cooperative relays scenario, information exchange between relay leads to high overhead.

12. Proposed Scheme

12.1 System Model: Proposed system model consist of totally three receivers. One is the information receiver (IR), other two ($J=2$) are energy harvesting receivers as well as eavesdroppers. The transmitter has equipped with N_t transmit antennas while the receivers are equipped with the single-antenna

In general, the harvesting-receivers are located near to the transmitter due to their low antenna sensitivities range and their signal processing techniques are quite different than Information receivers. On the other hand, receivers can be situated at longer distances than energy harvesting receivers due to good sensitivity capability.

Transmitters of the SWIPT systems can increase the energy of the information carrying signal to facilitate energy harvesting at the receiver. According to our system model, eavesdropper located near to the transmitter as energy harvester. So, it could decode more efficiently than IR due to more transmitter power availability.

The transmitted signal model of the transmitter is given by

$$X = \text{Energy signal } (W_E) + \text{Information signal } (W) \quad (1)$$

The above numerical equation represents the transmitted signal power. This signal is the combination of energy and information signals.

$$w_E \sim CN(0, \mathbf{W}_E,) \quad (2)$$

where w_E is a Gaussian pseudo-random vector, \mathbf{W}_E denotes the covariance of w_E vector and $\mathbf{W}_E \geq 0$, $\mathbf{W}_E \in \mathbf{H}^{N_t}$

Here, the energy signals sequence known at the legitimate receiver so that it can cancel via successive interference cancellation. However, this energy signals sequence not known at the potential eavesdropper so that transmitter can exploit these phenomena for providing the communication security.

In down link scenario, the received information is given by

$$y = \mathbf{h}^H \mathbf{x} + \text{noise} \quad (3)$$

here $\mathbf{X} \in \mathbf{C}^{N_t \times 1}$ denotes the transmitted symbol vector. $\mathbf{h} \in \mathbf{C}^{N_t \times 1}$ is the channel vector between the transmitter and the desired receiver. noise_j is the additive white Gaussian noise with zero mean and variance σ_{ant}^2 of i th signal.

$$y_j^{\text{ER}} = \mathbf{g}_j^H \mathbf{x} + \text{noise}_j \quad \forall j \in \{1, 2, 3\} \quad (4)$$

Here, Y_j^{ER} is the energy signal of j^{th} receiver, and noise_j is the additive white Gaussian noise with variance $\sigma_{\text{ant } j}^2$. $\mathbf{g}_j^H \in \mathbb{C}^{N_t \times 1}$ is the vector of the channel between the transmitter and energy receiver j . The both channel matrices \mathbf{h} , and \mathbf{g}_j include the channel impair parameters such as effects of the multipath fading and path loss of the associated channels.

Then, the total amount of power harvested by ER_j is given by

$$ER_{\text{ER}_j} = n_j \text{Tr} (\mathbf{G}_j^H (\mathbf{w}\mathbf{w}^H + \mathbf{W}_E) \mathbf{G}_j) \quad (5)$$

Here, n_j is the energy conversion coefficient ($0 \leq n_j \leq 1$).

Achievable Rate and Secrecy Rate:

We are assuming that perfect channel information available at transmitter for efficient beam form design. Furthermore, we have number of antennas $N_t \geq N_r$. Finally, the achievable rate (bit/s/Hz) between the transmitter and the IR is given by

$$R = \log_2 \left(1 + \frac{\mathbf{w}^H \mathbf{H} \mathbf{w}}{\text{Tr}(\mathbf{H} \mathbf{W}_E) + \sigma_{\text{ant}}^2 + \sigma_s^2} \right) \quad (6)$$

$$\leq \log_2 \left(1 + \frac{\mathbf{w}^H \mathbf{H} \mathbf{w}}{(\sigma_{\text{ant}}^2 + \sigma_s^2)} \right) \quad (7)$$

where the upper limit is due to fact that interference cancellation can be perform at the IR to remove $\mathbf{H} \mathbf{W}_E$ before attempting to decode the desired information.

Let we focus on the worst- case scenario for decoding capacity of the ERs. The achievable capacity between the transmitter and ER_j for decoding the signal of the IR after performing the interference cancellation to remove all multiuser interference and eavesdrops the message that intended for the IR is given by

$$R_{\text{ER}_j} = \log_2 \det (\mathbf{I}_{N_R} + \mathbf{Q}_j^{-1} \mathbf{G}_j^H \mathbf{w}\mathbf{w}^H \mathbf{G}_j) \quad (8)$$

$$\mathbf{Q}_j = \mathbf{G}_j^H (\mathbf{W}_E) \mathbf{G}_j + (\sigma_{\text{ant}}^2 + \sigma_s^2) \mathbf{I}_{N_R} > 0 \quad (9)$$

Here, \mathbf{Q}_j is the interference-plus-noise covariance matrix for ER_j assuming the worst case for communication secrecy. Thus, the achievable secrecy rate of the information receiver (IR) is given by

$$R_{\text{sec}} = [R - \text{MAX}_{\forall j} (R_{\text{ER}_j})]^+ \quad (10)$$

12.2 Maximum Capacity Rate of Eavesdropper:

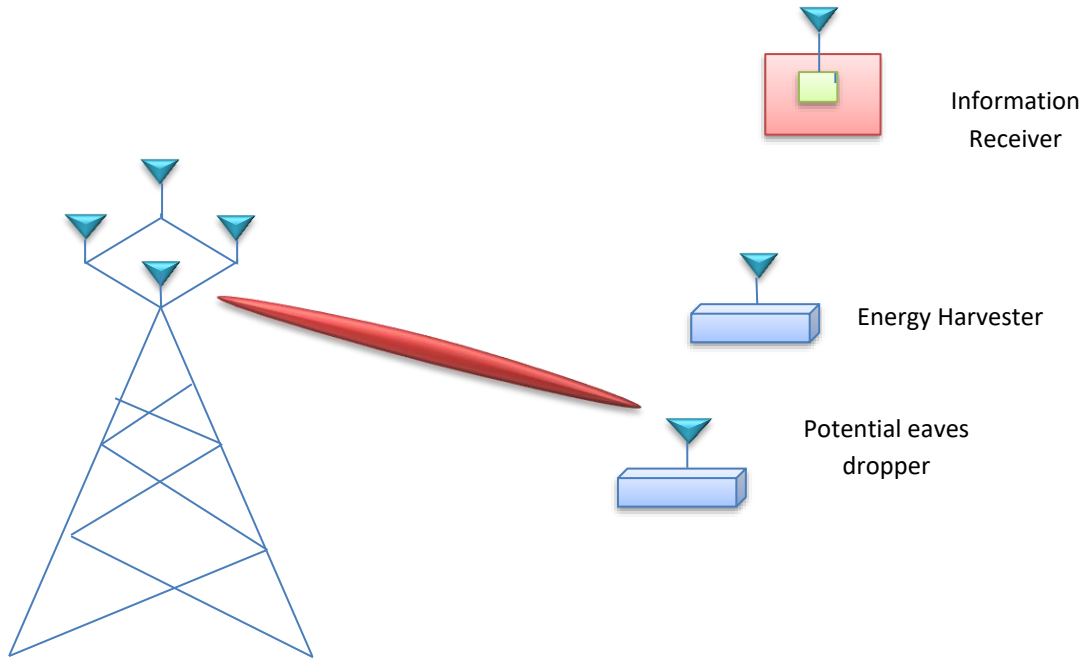

Figure 18: Transmitter beam form towards the Eavesdropper

From the above system, eavesdropper has single receiver antenna and transmitter has multiple antennas. So, the received signal at the eavesdropper is given by

$$y = [h_1, h_2, \dots, h_{N_T}]x + \text{Noise.} \quad (11)$$

Next, we perform the singular value decomposition on the channel matrix \mathbf{H} ($\mathbf{H} = \mathbf{h}\mathbf{h}^t$) $\mathbf{H} = \mathbf{U}\mathcal{T}^{1/2}\mathbf{V}$

$$\mathcal{T} = \begin{pmatrix} h_1 & \dots & 0 \\ \vdots & \ddots & \vdots \\ 0 & \dots & h_R \end{pmatrix} \quad (12)$$

where h_1, \dots, h_R the channel is gains between transmitter and receiver and they follow specific order such as $h_1 \geq h_2 \geq \dots \geq h_R$. Here, R is defined as the $R = \min \{N_T, J\}$, where, J is the no of eavesdropper (energy harvester), $\mathbf{U} \in \mathbb{C}^{J \times R}$ and $\mathbf{V} \in \mathbb{C}^{N_T \times R}$ are two matrices with orthonormal columns.

Here, in our case, $j=1$, and $R=1$. We chose the maximum channel gain (i.e. h_1)

According to Shannon channel capacity theorem, the maximum capacity rate of the eavesdropper in wireless channel is given by

$$R_{ER_{\max}} = \log_2 \left(1 + \left(\frac{|h_1|^2 P_{\text{total}}}{\sigma_{\text{ant}}^2 + \sigma_s^2} \right) \right) \text{ (bits/sec/Hz)} \quad (13)$$

Problem Formulation for proposed system:

$$\begin{aligned}
 & \text{Maximize} \\
 & \mathbf{W}, \mathbf{W}_E \in \mathbf{H}^{N_T} \text{ (Secrecy rate)} \\
 & \text{Subjected to:} \\
 & C_1: \frac{\mathbf{W}^H \mathbf{H} \mathbf{W}}{(\text{Tr}(\mathbf{H} \mathbf{W}_E) + \sigma_{\text{ant}}^2 + \sigma_s^2)} \geq \Gamma_{\text{req}} \\
 & C_2: \text{Tr}(\boldsymbol{\Phi}_{N_T, N_T} \mathbf{W}_E) + [\mathbf{W} \mathbf{W}^H]_{N_T, N_T} \leq P_{\text{max}_n} \quad (n=1, 2, 3, 4, \dots, N_T) \\
 & C_3: R_{\text{ER}_{\text{max}}} \geq R_{\text{ER}_j} \quad (j=1, 2, 3, \dots, \text{no of eavesdroppers}) \\
 & C_4: \mathbf{W} \succcurlyeq \mathbf{0}, \mathbf{W}_E \succcurlyeq \mathbf{0} \\
 & C_5: \text{Rank}(\mathbf{W}) \leq 1
 \end{aligned} \tag{14}$$

Secrecy rate is the difference between the information receiver capacity and capacity rate of potential eavesdropper.

Capacity rate of the information receiver is given by

$$R = \log_2 \left(1 + \left(\frac{\mathbf{W}^H \mathbf{H} \mathbf{W}}{(\text{Tr}(\mathbf{H} \mathbf{W}_E) + \sigma_{\text{ant}}^2 + \sigma_s^2)} \right) \right) \leq \log_2 \left(1 + \left(\frac{\mathbf{W}^H \mathbf{H} \mathbf{W}}{(\text{Tr}(\mathbf{H} \mathbf{W}_E) + \sigma_{\text{ant}}^2 + \sigma_s^2)} \right) \right) = R_{\text{max}} \tag{16}$$

Here, R_{max} is the maximum capacity rate of information getting by avoiding the interference term due to the energy signal

$$\text{Secrecy rate} = (R_{\text{max}} - R_{\text{ER}_{\text{max}}})^+ \tag{17}$$

In above problem, Γ_{req} is the minimum SNR required at the information receiver side (IR), σ_{ant}^2 is the thermal noise at receiver antenna side and σ_s^2 is the noise due to the signal processing. \mathbf{W} , and \mathbf{W}_E are the information, energy, and Noise matrices at the transmitter respectively. \mathbf{Q} is the interference term

(i.e. $\mathbf{Q} = \mathbf{G}^H(\mathbf{W}_E)\mathbf{G} + (\sigma_{\text{ant}}^2 + \sigma_s^2)\mathbf{I}_{N_R}$ and $R_{\text{ER}_{\text{max}}}$ is the maximum information decoding rate at the eavesdropper side.

$\boldsymbol{\Phi}_{N_T, N_T}$ is the square matrix given with the dimension of number of power transmission antenna

$$\boldsymbol{\Phi}_{N_T, N_T} = \boldsymbol{\varepsilon}_{(N_T, 1)} * \boldsymbol{\varepsilon}_{(1, N_T)}^t \quad \begin{cases} \varepsilon_{r,1} = 1 & r = n \text{ (where } n = 1, 2, 3, \dots, N_T) \\ \varepsilon_{r,1} = 0 & \text{else} \end{cases} \tag{18}$$

$\boldsymbol{\Phi}_{N_T, N_T}$ is the square matrix with dimension of N_T and $\boldsymbol{\varepsilon}_{r,1}$ is the r_{th} unit column vector .

The above problem is non-convex optimization problem due to non-convexity of constrain C_1 and C_3 . The non-convexity of constraint C_3 due to the log functions and not facilitates the traceable beam form design. For avoiding this problem, we are changing them in to the equivalent form [41, 48, 42]

Proposition.1. For maximum capacity rate of eavesdropper $R_{ER_{max}} > 0$, the following condition will hold

$$C_3 \Rightarrow \bar{C}_3 : (\mathbf{G}^H \mathbf{W} \mathbf{G}) \leq \alpha_{max} * \mathbf{Q} \quad (19)$$

Where $\alpha_{max} = (2^{R_{ER_{max}}} - 1)$ is the auxiliary constant and \bar{C}_3 is the Linear Matrix Inequality (LMI) constraint and $C_3 \Leftrightarrow \bar{C}_3$.

Maximize
 $\mathbf{W}, \mathbf{W}_E \in \mathbf{H}^{N_T}$ (Secrecy rate)

Subjected to :

$C_1: \text{Tr}(\mathbf{H}\mathbf{W}) \geq \Gamma_{req}(\text{Tr}(\mathbf{H}\mathbf{W}_E) + \sigma_{ant}^2 + \sigma_s^2)$

$C_2: \text{Tr}(\boldsymbol{\varphi}_{N_T, N_T} \mathbf{W}_E) + \text{Tr}(\boldsymbol{\varphi}_{N_T, N_T} \mathbf{W}) \leq P_{max_n} \quad (n= 1, 2, 3, 4, \dots, N_T)$

$C_3: (\mathbf{G}^H \mathbf{W} \mathbf{G}) \leq (2^{R_{ER_{max}}} - 1) * \mathbf{Q}$

$C_4: \mathbf{W} \succcurlyeq \mathbf{0}, \mathbf{W}_E \succcurlyeq \mathbf{0},$

$C_5: \text{Rank}(\mathbf{W}) \leq 1 \quad (20)$

Here, only the problem is due to the constrain C_6 and it is a combinatorial constraint and require a brute force search for find the better (optimal) solution. For circumvent the this problem, we use the semi definite relaxation (SDP) ($\text{rank}(\mathbf{W})=1$) i.e., we remove the C_6 from the problem

The new problem is given by

Maximize
 $\mathbf{W}, \mathbf{W}_E \in \mathbf{H}^{N_T}$ (Z)

Subjected to

$C_1: \text{Tr}(\mathbf{H}\mathbf{W}) \geq \Gamma_{req}(\text{Tr}(\mathbf{H}\mathbf{W}_E) + \sigma_{ant}^2 + \sigma_s^2)$

$C_2: \text{Tr}(\boldsymbol{\varphi}_{N_T, N_T} \mathbf{W}_E) + \text{Tr}(\boldsymbol{\varphi}_{N_T, N_T} \mathbf{W}) \leq P_{max_n} \quad (n= 1, 2, 3, 4, \dots, N_T)$

$C_3: (\mathbf{G}^H \mathbf{W} \mathbf{G}) \leq (2^{R_{ER_{max}}} - 1) * \mathbf{Q}$

$C_4: \mathbf{W} \succcurlyeq \mathbf{0}, \mathbf{W}_E \succcurlyeq \mathbf{0},$

$C_5: \text{Rank}(\mathbf{W}) \leq 1$

$C_6: Z \leq \text{Tr}(\mathbf{H}\mathbf{W}) \quad (21)$

From above problem, Z is the variable and its upper limit is set to the total information power received at the receiver i.e. $\text{Tr}(\mathbf{HW})$. So, the solution of above problem (i.e. Z value) is used for calculating the Information rate capacity.

The new Information rate is given by

$$\log_2 \left(1 + \left(\frac{Z}{\sigma_{ant}^2 + \sigma_s^2} \right) \right) = R_{max} \quad (22)$$

Finally, the secrecy rate is given by

$$\text{Secrecy rate} = (R_{max} - R_{ER_{max}})^+ \quad (23)$$

13. RESULTS:

In this section, we calculate the secrecy rate by using the proposed resource allocation method. We summarize the relevant simulation parameters in Table 1. In this system, potential eavesdropper located at 5 meter away and the information receiver (IR) is located at 100 meter away from the transmitter respectively.

Carrier frequency (f_c)	915MHz
System Bandwidth	200KHz
Transceiver antenna gain (G_t, G_r)	10dBi
Noise variance σ^2	-92dBm
Min. harvested power at each ER P_{reqj}^{min}	3dBm
Transmitter-to-ER fading distribution	Rician with Rician factor 3 dB
Transmitter-to-IR fading distribution	Rayleigh

Table 3: Simulation Parameters.

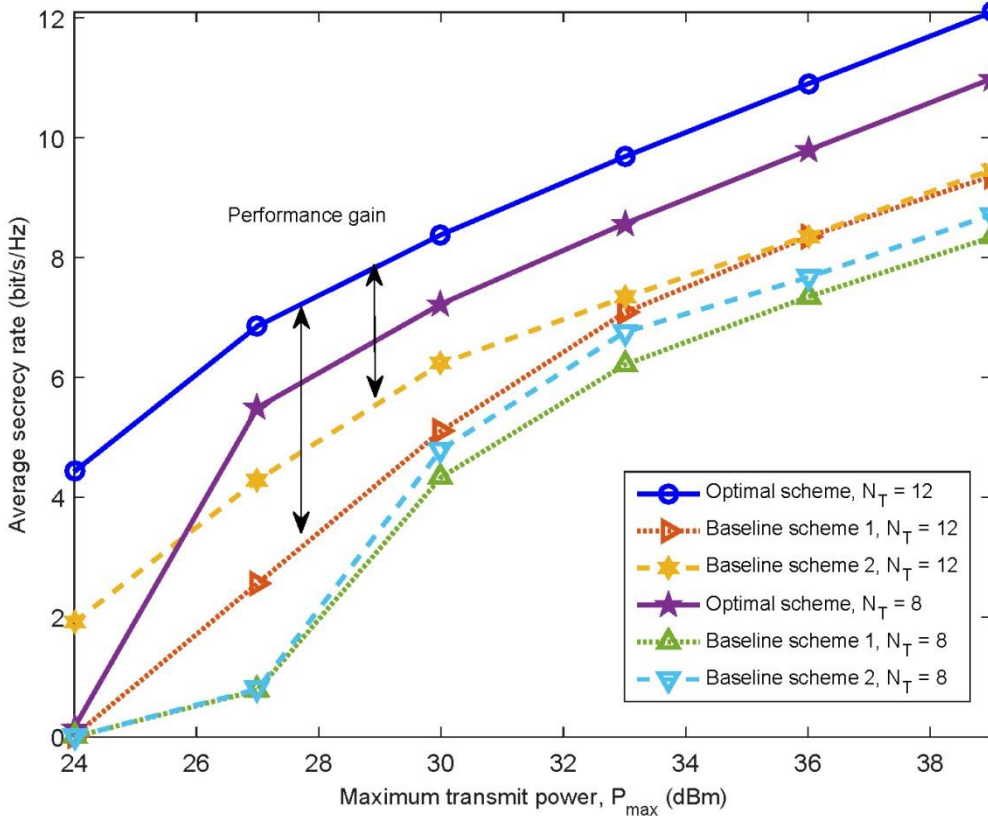

Figure 19: Secrecy rate versus different power transmit power level for different level transmit antennas

We can observe that secrecy rate increases with increasing the transmitting power. Indeed, the information capacity rate increasing by increasing the transmit power level (P_t). In addition, channel quality of the information towards the Energy Receiver(ER) degraded by higher transmitting power (P_t). On the other hand, secrecy rate increases for the given power level by increasing the number of transmitting antennas because the beam spatial degrees of freedom offered by extra transmit antennas facilitate a more flexible beam forming and steer the beam form toward the energy receiver without causing any interference with other channels. We also verify the proposed resource allocation scheme with base line scheme.

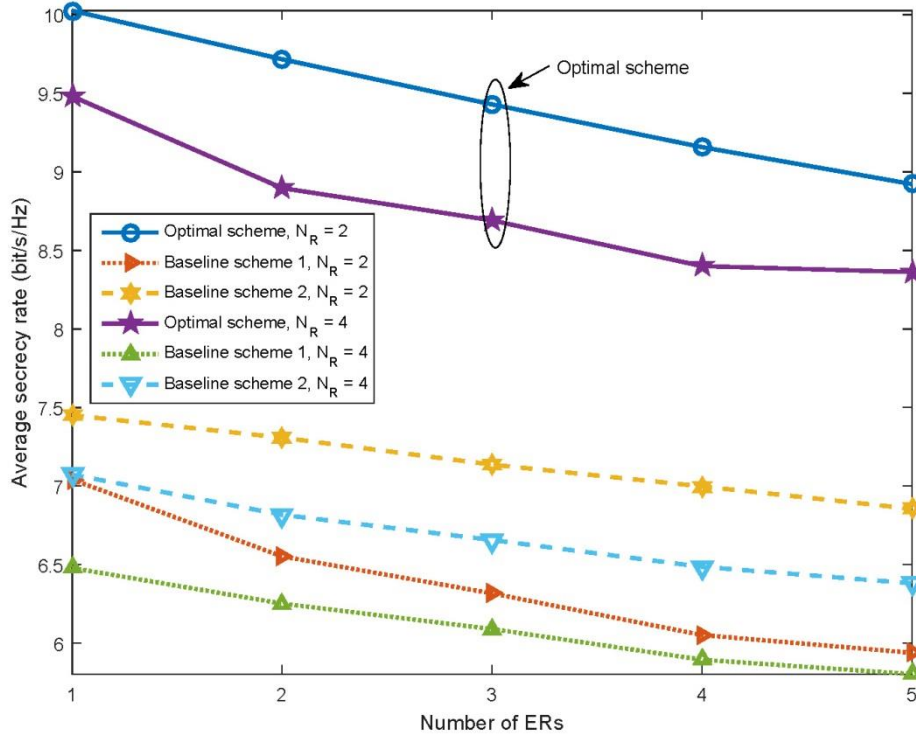

Figure 20: The Average secrecy rate versus different level of Energy receivers

In this scenario, we set the maximum transmitting power (P_t) to 33dBm and evaluated the secrecy rate for different number of energy harvesters. Secrecy rate decreasing non-linearly by increasing the energy harvesters. The transmitter is forced to focus some of the energy of the information signal towards the ERs in order to satisfy the constraints. Second, there are more potential eavesdroppers present in the system resulting in higher potential for information leakage. Thus, a higher amount of transmit power has to be allocated to the energy signal for interfering the ERs to guarantee communication secrecy. Hence, less power can be allocated to the desired signal. Also, it can be observed that the average secrecy rate decreases with the number of antennas equipped at each ER, N_R . In fact, the signal reception capability other ERs improve with N_R . We also compares the performance of the proposed optimal beam forming scheme with the two baseline schemes. As expected, the optimal scheme outperforms

the baseline schemes. This is because the proposed optimal scheme is able to fully exploit the available degrees of freedom for efficient beam forming design.

14. Conclusion:

The main objective of this Proposal is to maximize the secrecy rate by allocating optimal beam form scheme with the given limited power resource. The beam forming designs for the scenarios considered have been formulated as non-convex optimization problems and were solved optimally via SDP relaxation. The tightness of the SDP relaxation was checked by considering the Lagrange Dual problem. Secrecy rate for the proposed system model evaluated by considering the one dimensional search and semi-definite programming (SDP). Finally, we concluded that transmitting power, optimal beam form design, and number of transmitting antennas are the key tools for enhancing the secrecy rate in SWIPT systems. Besides, simulation results show that proposed resource allocation scheme performed better than base line scheme.

15. REFERENCES:

- [1] Z. Ding, C. Zhong, D. W. K. Ng et al., “Application of smart antenna technologies in simultaneous wireless information and power transfer,” *IEEE Communications Magazine*, vol. 53, no. 4, pp. 86–93, April 2015.
- [2] L. Varshney, “Transporting information and energy simultaneously,” in *Proc. IEEE International Symposium on Information Theory*, July 2008, pp. 1612–1616.
- [3] P. Grover and A. Sahai, “Shannon meets Tesla: Wireless information and power transfer,” in *Proc. IEEE International Symposium on Information Theory*, June 2010, pp. 2363–2367.
- [4] I. Krikidis, S. Mothéou, S. Nikolaou et al., “Simultaneous wireless information and power transfer in modern communication systems,” *IEEE Communications Magazine*, vol. 52, no. 11, pp. 104–110, November 2014.
- [5] Z. Ding, C. Zhong, D. W. K. Ng et al., “Application of smart antenna technologies in simultaneous wireless information and power transfer,” *IEEE Communications Magazine*, vol. 53, no. 4, pp. 86–93, April 2015.
- [6] X. Chen, Z. Zhang, H.-H. Chen, and H. Zhang, “Enhancing wireless information and power transfer by exploiting multi-antenna techniques,” *IEEE Communications Magazine*, no. 4, pp. 133–141, April 2015.
- [7] Powercast Corporation, *RF Energy Harvesting and Wireless Power for Low-Power Applications*, 2011 (available at www.mouser.com/pdfdocs/Powercast-Overview-2011-01-25.pdf).
- [8] A. Sample and J. Smith, “Experimental results with two wireless power transfer systems,” in *Proc. IEEE Radio and Wireless Symposium*, January 2009, pp. 16–18.
- [9] R. Zhang and C. K. Ho, “MIMO broadcasting for simultaneous wireless information and power transfer,” in *Proc. IEEE Global Telecommunications Conference*, December 2011, pp. 1–5.
- [10] L. Liu, R. Zhang, and K.-C. Chua, “Wireless information transfer with opportunistic energy harvesting,” *IEEE Transactions on Wireless Communications*, vol. 12, no. 1, pp. 288–300, January 2013.
- [11] X. Zhou, R. Zhang, and C. K. Ho, “Wireless information and power transfer: Architecture design and rate–energy tradeoff,” *IEEE Transaction on Communication*, vol. 61, pp. 4754–4767, November 2013.

- [12] D. W. K. Ng, E. S. Lo, and R. Schober, "Wireless information and power transfer: Energy efficiency optimization in OFDMA systems," *IEEE Transaction on Wireless Communications*, vol. 12, pp. 6352–6370, December 2013.
- [13] D. W. K. Ng and R. Schober, "Resource allocation for secure communication in systems with wireless information and power transfer," in *Proc. IEEE Global Telecommunications Conference*, December 2013.
- [14] D. W. K. Ng and R. Schober, "Spectral efficient optimization in OFDM systems with wireless information and power transfer," in *21st European Signal Processing Conference (EUSIPCO)*, September 2013, pp. 1–5.
- [15] D.W.K. Ng, E.S. Lo, and R.Schober, "Energy-efficient power allocation in OFDM systems with wireless information and powertransfer,"in*Proc.IEEEInternationalCommunications Conference*, June 2013, pp. 4125–4130.
- [16] D. W. K. Ng, E. S. Lo, and R. Schober, "Robust beamforming for secure communication in systems with wireless information and power transfer," *IEEE Transactions on Wireless Communications*, vol. 13, pp. 4599–4615, August 2014.
- [17] R. T. Marler and J. S. Arora, "Survey of multi-objective optimization methods for engineering," *Structural and Multidisciplinary Optimization*, vol. 26, pp. 369–395, April 2004.
- [18] L. Liu, R. Zhang, and K.-C. Chua, "Secrecy wireless information and power transfer with MISO beamforming," *IEEE Transactions on Signal Processing*, vol. 62, pp. 1850–1863, April 2014.
- [19] C. Y. Wong, R. S. Cheng, K. B. Letaief, and R. D. Murch, "Multiuser OFDM with adaptive subcarrier, bit, and power allocation," *IEEE Journal on Selected Areas in Communications*, vol. 17, pp. 1747–1758, October 1999.
- [20] V. K. N. Lau and Y. K. Kwok, *Channel Adaptation Technologies and Cross Layer Design for Wireless Systems with Multiple Antennas—Theory and Applications*, Istedn.NewYork: Wiley, 2005.
- [21] W.-L. Li, Y. J. Zhang, A.-C. So, and M. Win, "Slow adaptive OFDMA systems through chance constrained programming," *IEEE Transactions on Signal Processing*, vol. 58, pp. 3858–3869, July 2010.
- [22] D. W. K. Ng, E. S. Lo, and R. Schober, "Energy-efficient resource allocation in multicell OFDMA systems with limited backhaul capacity," *IEEE Transactions on Wireless Communications*, vol. 11, pp. 3618–3631, October 2012.

- [23] D. W. K. Ng and R. Schober, "Cross-layer scheduling for OFDMA amplify-and-forward relay networks," *IEEE Transactions on Vehicular Technology*, vol. 59, pp. 1443–1458, March 2010.
- [24] D. W. K. Ng, E. S. Lo, and R. Schober, "Dynamic resource allocation in MIMO-OFDMA systems with full-duplex and hybrid relaying," *IEEE Transactions on Communication*, vol. 60, May 2012.
- [25] H. Jabbar, Y. Song, and T. Jeong, "RF energy harvesting system and circuits for charging of mobile devices," *IEEE Transactions on Consumer Electronics*, vol. 56, pp. 247–253, February 2010.
- [26] X. Zhou, R. Zhang, and C. K. Ho, "Wireless information and power transfer: Architecture design and rate–energy tradeoff," in *Proc. IEEE Global Telecommunications Conference*, December 2012.
- [27] R. Zhang and C. K. Ho, "MIMO broadcasting for simultaneous wireless information and power transfer," *IEEE Transactions on Wireless Communications*, vol. 12, pp. 1989–2001, May 2013.
- [28] E. Boshkovska, D. Ng, N. Zlatanov, and R. Schober, "Practical non-linear energy harvesting model and resource allocation for SWIPT systems," *IEEE Communication Letters*, arXiv:1509.02956v1, 2015.
- [29] S. Leng, D. W. K. Ng, N. Zlatanov, and R. Schober, "Multi-objective beamforming for energy-efficient SWIPT systems," in *Proc. International Conference on Computing, Networking and Communications*, February 2016.
- [30] D. W. K. Ng, E. S. Lo, and R. Schober, "Energy-efficient resource allocation in multiuser OFDM systems with wireless information and power transfer," in *Proc. IEEE Wireless Communications and Networking Conference*, 2013.
- [31] S. Leng, D. W. K. Ng, and R. Schober, "Power efficient and secure multi user communication systems with wireless information and power transfer," in *Proc. IEEE International Communications Conference*, June 2014.
- [32] D. W. K. Ng, L. Xiang, and R. Schober, "Multi-objective beamforming for secure communication in systems with wireless information and power transfer," in *Proc. IEEE Personal, Indoor and Mobile Radio Communication Symposium*, September 2013.
- [33] D. W. K. Ng, R. Schober, and H. Alnuweiri, "Secure layered transmission in multicast systems with wireless information and power transfer," in *Proc. IEEE International Communications Conference*, June 2014, pp. 5389–5395.
- [34] D. W. K. Ng and R. Schober, "Resource allocation for coordinated multipoint networks with wireless information and power transfer," in *Proc. IEEE Global Telecommunications Conference*, December 2014, pp. 4281–4287.

- [35] M. Chynonova, R. Morsi, D. W. K. Ng, and R. Schober, "Optimal multiuser scheduling schemes for simultaneous wireless information and power transfer," in 23rd European Signal Processing Conference (EUSIPCO), August 2015.
- [36] Q. Wu, M. Tao, D. W. K. Ng, W. Chen, and R. Schober, "Energy-efficient transmission for wireless powered multiuser communication networks," in Proc. IEEE International Communications Conference, June 2015.
- [37] D. Ng and R. Schober, "Max-min fair wireless energy transfer for secure multiuser communication systems," in IEEE Information Theory Workshop (ITW), November 2014, pp. 326–330.
- [38] X. Chen, C. Yuen, and Z. Zhang, "Wireless energy and information transfer tradeoff for limited-feedback multiantenna systems with energy beamforming," IEEE Transactions on Vehicular Technology, vol. 63, pp. 407–412, January 2014.
- [39] H. Wang, W. Wang, X. Chen, and Z. Zhang, "Wireless information and energy transfer in interference aware massive MIMO systems," in Proc. IEEE Global Telecommunications Conference, December 2014, pp. 2556–2561.
- [40] IEEE P802.11 Wireless LANs, "TGn channel models", IEEE 802.11-03/940r4, technical report, May 2004.
- [41] J. F. Sturm, "Using SeDuMi 1.02, a MATLAB toolbox for optimization over symmetric cones," Optimization Methods and Software, vol. 11–12, pp. 625–653, September 1999.
- [42] K. C. Toh, M. J. Todd, and R. H. Tütüncü, "SDPT3 – A Matlab software package for semidefinite programming, version 1.3," Optimization Methods and Software, vol. 11, pp. 545–581, January 1999.
- [43] G. Zheng, K. K. Wong, and T. S. Ng, "Robust linear MIMO in the downlink: A worst-case optimization with ellipsoidal uncertainty regions," EURASIP Journal on Advances in Signal Processing, article ID 609028, 2008.
- [44] C. Shen, T.-H. Chang, K.-Y. Wang, Z. Qiu, and C.-Y. Chi, "Distributed robust multicell coordinated beamforming with imperfect CSI: An ADMM approach," IEEE Transactions on Signal Processing, vol. 60, pp. 2988–3003, June 2012.
- [45] N. Vucic and H. Boche, "Robust QoS-constrained optimization of downlink multiuser MISO systems," IEEE Transactions on Signal Processing, vol. 57, pp. 714–725, February 2009.
- [46] J. Wang and D. Palomar, "Worst-case robust MIMO transmission with imperfect channel knowledge," IEEE Transactions on Signal Processing, vol. 57, pp. 3086–3100, August 2009.

- [47] S. Boyd and L. Vandenberghe, *Convex Optimization*. Cambridge: Cambridge University Press, 2004.
- [48] M. Grant and S. Boyd, *CVX: Matlab Software for Disciplined Convex Programming, Version 2.0 Beta*, September 2013.
- [49] D. W. K. Ng, E. S. Lo, and R. Schober, “Multi-objective resource allocation for secure communication in cognitive radio networks with wireless information and power transfer,” *IEEE Transactions on Vehicular Technology*, arXiv:1403.0054, May 2015.
- [50] E. Björnson and E. Jorswieck, *Optimal Resource Allocation in Coordinated Multi-Cell Systems*. Boston, MA: Now Publishers Inc., 2013.
- [51] Z. Hasan, G. Bansal, E. Hossain, and V. Bhargava, “Energy-efficient power allocation in OFDM-based cognitive radio systems: A risk–return model,” *IEEE Transactions on Wireless Communications*, vol. 8, pp. 6078–6088, December 2009.
- [52] D. W. K. Ng, E. Lo, and R. Schober, “Energy-efficient resource allocation in OFDMA systems with large numbers of base station antennas,” *IEEE Transactions on Wireless Communications*, vol. 11, pp. 3292–3304, September 2012.
- [53] D. W. K. Ng, E. S. Lo, and R. Schober, “Energy-efficient resource allocation in OFDMA systems with hybrid energy harvesting base station,” *IEEE Transactions on Wireless Communications*, vol. 12, pp. 3412–3427, July 2013.
- [54] X. Chen, X. Wang, and X. Chen, “Energy-efficient optimization for wireless information and power transfer in large-scale MIMO systems employing energy beamforming,” *IEEE Wireless Communications Letters*, vol. 2, pp. 1–4, December 2013.
- [55] A. D. Wyner, “The wire-tap channel,” *The Bell System Technical Journal*, vol. 54, no. 8, pp. 1355–1387, October 1975.
- [56] S. Goel and R. Negi, “Guaranteeing secrecy using artificial noise,” *IEEE Transactions on Wireless Communications*, vol. 7, pp. 2180–2189, June 2008.
- [57] D. W. K. Ng, E. S. Lo, and R. Schober, “Secure resource allocation and scheduling for OFDMA decode-and-forward relay networks,” *IEEE Transactions on Wireless Communications*, vol. 10, pp. 3528–3540, August 2011.
- [58] X. Chen and H.-H. Chen, “Physical layer security in multi-cell MISO downlinks with incomplete CSI – A unified secrecy performance analysis,” *IEEE Transactions on Signal Processing*, vol. 62, pp. 6286–6297, December 2014.

- [59] D. W. K. Ng, E. S. Lo, and R. Schober, "Efficient resource allocation for secure OFDMA systems," *IEEE Transactions on Vehicular Technology*, vol. 61, pp. 2572–2585, July 2012.
- [60] J. Zhu, V. K. Bhargava, and R. Schober, "Secure downlink transmission in massive MIMO system with zero-forcing precoding," in *Proc. European Wireless Conference*, May 2014, pp. 1–6. [61] L. Liu, R. Zhang, and K.-C. Chua, "Secrecy wireless information and power transfer with MISO beamforming," in *Proc. IEEE Global Telecommunications Conference*, December 2013.
- [62] D. W. K. Ng and R. Schober, "Secure and green SWIPT in distributed antenna networks with limited backhaul capacity," *IEEE Transactions on Wireless Communications*, vol. 14, no. 9, pp. 5082–5097, September 2015.
- [63] Q. Wang, H. Su, K. Ren, and K. Kim, "Fast and scalable secret key generation exploiting channel phase randomness in wireless networks," in *Proc. IEEE International Conference on Computer Communications*, April 2011, pp. 1422–1430.
- [64] J. Zhu, R. Schober, and V. Bhargava, "Secure transmission in multicell massive MIMO systems," *IEEE Transactions Wireless Communications*, vol. 13, pp. 4766–4781, September 2014.
- [65] X. Chen, J. Chen, and T. Liu, "Secure wireless information and power transfer in large-scale MIMO relaying systems with imperfect CSI," in *Proc. IEEE Global Telecommunications Conference*, December 2014, pp. 4131–4136
- [66] A. Charnes and W. W. Cooper, "Programming with linear fractional functions," *Naval Research Logistics Quarterly*, vol. 9, pp. 181–186, April 1962.
- [67] Q. Li and W. K. Ma, "Spatially selective artificial-noise aided transmit optimization for MISO multi-eves secrecy rate maximization," *IEEE Transactions on Signal Processing*, vol. 61, pp. 2704–2717, May 2013.
- [68] P. Grover and A. Sahai, "Shannon meets Tesla: wireless information and power transfer," in *Proc. IEEE Int. Symp. Inf. Theory (ISIT)*, pp. 2363–2367, Jun. 2010.
- [69] K. Huang and E. G. Larsson, "Simultaneous information and power transfer for broadband wireless systems," *IEEE Trans. Signal Process.*, vol. 61, no. 23, pp. 5972–5986, Dec. 2013.
- [70] X. Chen, C. Zhong, C. Yuen, and H.-H. Chen, "Multi-antenna relay aided wireless physical layer security," *IEEE Commun. Mag.*, vol. 53, no. 12, pp. 40–46, Dec. 2015.
- [71] P. K. Gopala, L. Lai, and H. El. Gamal, "On the secrecy capacity of fading channels," *IEEE Trans. Inf. Theory*, vol. 54, no. 10, pp. 4687–4698, Oct. 2008.

- [72] L. Liu, R. Zhang, and K-C. Chua, "Secrecy wireless information and power transfer with MISO beamforming," *IEEE Trans.Signal Process.*, vol. 62, no. 7, pp. 1850-1863, Apr. 2014.
- [73] R. Feng, Q. Li, Q. Zhang, and J. Qin, "Robust secure transmission in MISO simultaneous wireless information and power transfer system," *IEEE Trans. Veh. Technol.*, vol. 64, no. 1, pp. 400-405, Jan. 2015.
- [74] D. W. K. Ng, E. S. Lo, and R. Schober, "Robust beamforming for secure communication in systems with wireless information and power transfer," *IEEE Trans. Wireless Commun.*, vol. 13, no. 8, pp. 4599-4615, Aug. 2014.
- [75] X. Chen, J. Chen, and T. Liu, "Secure wireless information and power transfer in large-scale MIMO relaying systems with Imperfect CSI," in *Proc. IEEE GLOBECOM*, pp. 4131-4136, Dec. 2014.
- [76] X. Huang, Q. Li, Q. Zhang, and J. Qin, "Power allocation for secure OFDMA systems with wireless information and power transfer," *Electronics Lett.*, vol. 50, no. 3, pp. 229-230, Mar. 2014.
- [77] D. W. K. Ng, E. S. Lo, and R. Schober, "Multi-Objective resource allocation for secure communication in cognitive radio networks with wireless information and power transfer," *IEEE Trans. Veh. Technol.*, 2015. [DOI]:10.1109/TVT.2015.2436334.
- [78] Q. Shi, W. Xu, J. Wu, E. Song, and Y. Wang, "Secure beamforming for MIMO broadcasting with wireless information and power transfer," *IEEE Trans. Wireless Commun.*, vol. 14, no. 5, pp. 2841-2853, May 2015.
- [79] X. Chen, Z. Zhang, H-H. Chen, and H. Zhang, "Enhancing wireless information and power transfer by exploiting multiantenna techniques," *IEEE Commun. Mag.*, vol. 53, no. 4, pp. 133-141, Apr. 2015.
- [80] M. Tian, X. Huang, Q. Zhang, J. Qin, "Robust AN-aided secure transmission scheme in MISO channels with simultaneous wireless information and power transfer," *IEEE Signal Process. Lett.*, vol. 22, no. 6, pp. 723-727, Jun. 2015.
- [81] T. L. Marzetta, "Noncooperative cellular wireless with unlimited numbers of base station antennas," *IEEE Trans. Wireless Commun.*, vol. 9, no. 11, pp. 3590-3600, Nov. 2010.
- [82] B. M. Hochwald, T. L. Marzetta, and V. Tarokh, "Multiple-antenna channel hardening and its implications for rate-feedback and scheduling," *IEEE Trans. Inf. Theory*, vol. 50, no. 9, pp. 1893-1909, Sept. 2004.

16. Theorem Proofs

16.1 Proof of Theorem1:

$$\underset{\mathbf{W} \in \mathbf{H}^{N_T}}{\text{Maximize}} L(Z, \mathbf{\Omega}, \boldsymbol{\alpha}, \beta, \gamma, \theta, v) = 0$$

$$\Rightarrow Z - \mathbf{\Omega} \mathbf{W} - \boldsymbol{\alpha} \mathbf{W}_E + \beta (\Gamma_{\text{req}}(\text{Tr}(\mathbf{H} \mathbf{W}_E) + \text{Total noise}) - \text{Tr}(\mathbf{H} \mathbf{W})) + \sum_{n=1}^{N_T} \gamma_n ((\text{Tr}(\boldsymbol{\varphi}_{N_T, N_T} \mathbf{W}_E) + \text{Tr}(\boldsymbol{\varphi}_{N_T, N_T} \mathbf{W}) - P_{\max_n}) + \theta (Z - \text{Tr}(\mathbf{H} \mathbf{W})) + v ((\mathbf{G}^H \mathbf{W} \mathbf{G}) - (2^{T_{\max}} - 1) \mathbf{Q})) \quad (23)$$

$$\Rightarrow \frac{dL(\Omega, \alpha, \beta, \gamma, \theta, v)}{d\mathbf{W}} = 0$$

$$\frac{dZ}{d\mathbf{W}} - \frac{d(\mathbf{\Omega} \mathbf{W})}{d\mathbf{W}} - \frac{d(\boldsymbol{\alpha} \mathbf{W}_E)}{d\mathbf{W}} + \frac{d\beta (\Gamma_{\text{req}}(\text{Tr}(\mathbf{H} \mathbf{W}_E) + \text{Total noise}) - \text{Tr}(\mathbf{H} \mathbf{W}))}{d\mathbf{W}} + \frac{d\theta (Z - \text{Tr}(\mathbf{H} \mathbf{W}))}{d\mathbf{W}} + \frac{dv ((\mathbf{G}^H \mathbf{W} \mathbf{G}) - (2^{T_{\max}} - 1) \mathbf{Q})}{d\mathbf{W}} + \frac{d \sum_{n=1}^{N_T} \gamma_n ((\text{Tr}(\boldsymbol{\varphi}_{N_T, N_T} \mathbf{W}_E) + \text{Tr}(\boldsymbol{\varphi}_{N_T, N_T} \mathbf{W}) - P_{\max_n})}{d\mathbf{W}} = 0 \quad (24)$$

$$-\mathbf{\Omega} - \beta \mathbf{H} - \theta \mathbf{H} + v (\mathbf{G}^H \mathbf{G}) + \sum_{n=1}^{N_T} \gamma_n (\boldsymbol{\varphi}_{N_T, N_T}) = 0 \quad (25)$$

$$\mathbf{\Omega} = v (\mathbf{G}^H \mathbf{G}) + \sum_{n=1}^{N_T} \gamma_n (\boldsymbol{\varphi}_{N_T, N_T}) - \beta \mathbf{H} - \theta \mathbf{H} \quad (26)$$

$$\mathbf{\Omega} = v (\mathbf{G}^H \mathbf{G}) + \sum_{n=1}^{N_T} \gamma_n (\boldsymbol{\varphi}_{N_T, N_T}) - \mathbf{H}(\beta + \theta) \quad (27)$$

$$\text{Let } \mathbf{A} = v (\mathbf{G}^H \mathbf{G}) + \sum_{n=1}^{N_T} \gamma_n (\boldsymbol{\varphi}_{N_T, N_T}) \quad (28)$$

$$\mathbf{\Omega} = \mathbf{A} - \mathbf{H}(\beta + \theta) \quad (29)$$

where $\mathbf{\Omega}, \boldsymbol{\alpha}, \beta, \gamma, \theta, v$ are the Lagrangian variable (which also called the optimal Lagrangian multipliers) $\mathbf{\Omega}$ is the slack variable for the \mathbf{W} variable and columns of the \mathbf{W} matrix lies in the null space of the $\mathbf{\Omega}$. Thus, if the rank of $\mathbf{\Omega}$ is $N_T - 1$ then the rank of \mathbf{W} will be one and optimal Eigen value obtained from the Eigen value decomposition.

We prove the above statement by assuming that \mathbf{A} is the full rank matrix with rank N_T . Let we consider the dual Problem and their parameters. For given set of optimal variable, $D = \{\mathbf{\Omega}, \boldsymbol{\alpha}, \beta, \gamma, \theta, v\}$, the Lagrange dual problem can be written as

$$\underset{\mathbf{w}, \mathbf{w}_E \in \mathbf{H}^{N_T}, Z}{\text{maximize}} (L(Z, \mathbf{\Omega}, \boldsymbol{\alpha}, \beta, \gamma, \theta, v)) \quad (30)$$

Suppose, we consider $\mathbf{\Omega}$ as the positive semi definite (i.e $\mathbf{\Omega} \preceq \mathbf{0}$) and we chose the beam former as the solution for the Lagrangian problem. So $\mathbf{W} = \text{tw} \mathbf{w}^H$ as considered as the solution for the problem

$$\Rightarrow Z - \mathbf{\Omega} \text{tw} \mathbf{w}^H - \boldsymbol{\alpha} \mathbf{W}_E - \mu V + \beta (\Gamma_{\text{req}}(\text{Tr}(\mathbf{H} \mathbf{W}_E) + \text{Total noise}) - \text{Tr}(\mathbf{H} \text{tw} \mathbf{w}^H)) + \sum_{n=1}^{N_T} \gamma_n ((\text{Tr}(\boldsymbol{\varphi}_{N_T, N_T} \mathbf{W}_E) + \text{Tr}(\boldsymbol{\varphi}_{N_T, N_T} \text{tw} \mathbf{w}^H) - P_{\max_n}))$$

$$\boldsymbol{\varphi}_{N_T, N_T} \mathbf{W}_E) + \text{Tr}(\boldsymbol{\varphi}_{N_T, N_T} \text{tw} \mathbf{w}^H) - P_{\max_n}) + \theta(Z - \text{Tr}(\mathbf{H} \text{tw} \mathbf{w}^H)) + \nu((\mathbf{G}^H \text{tw} \mathbf{w}^H \mathbf{G}) - (2^{T_{\max}} - 1)\mathbf{Q}) \quad (31)$$

$$\Rightarrow \nu(\mathbf{G}^H \text{tw} \mathbf{w}^H \mathbf{G}) + \sum_{n=1}^{N_T} \gamma_n \text{Tr}(\boldsymbol{\varphi}_{N_T, N_T} \text{tw} \mathbf{w}^H) - t \text{Tr}(\text{w} \mathbf{w}^H (\boldsymbol{\Omega} + \beta \mathbf{H} + \theta \mathbf{H}) + Z - \boldsymbol{\alpha} \mathbf{W}_E) + \beta(\Gamma_{\text{req}}(\text{Tr}(\mathbf{H} \mathbf{W}_E) + \text{Total noise}) + \sum_{n=1}^{N_T} \gamma_n ((\text{Tr}(\mathbf{W}_E) - P_{\max_n})) + \theta(Z) - \nu((2^{T_{\max}} - 1)\mathbf{Q})) \quad (32)$$

$$\text{Tr}(\mathbf{A} \text{tw} \mathbf{w}^H) - t \text{Tr}(\text{w} \mathbf{w}^H (\boldsymbol{\Omega} + \beta \mathbf{H} + \theta \mathbf{H})) + \Delta \quad (33)$$

here $\Delta = Z - \boldsymbol{\alpha} \mathbf{W}_E + \beta(\Gamma_{\text{req}}(\text{Tr}(\mathbf{H} \mathbf{W}_E) + \text{Total noise}) + \sum_{n=1}^{N_T} \gamma_n ((\text{Tr}(\mathbf{W}_E) - P_{\max_n})) + \nu((2^{T_{\max}} - 1)\mathbf{Q}))$ and it is independent on the beam form solution (i.e. $\mathbf{W} = \text{tw} \mathbf{w}^H$).

On the other hand, we assumed that channels between transmitter and information receiver (h), energy receiver (g_i) are assumed to be statically independent. So, if we set the $t \rightarrow \infty$, dual problem become unbounded from the below. But, the optimal value of the primal problem is strictly positive for minimum required SNR ($\Gamma_{\text{req}} > 0$). Thus, our matrix \mathbf{A} is semi definite positive with probability 1 i.e. rank of \mathbf{A} is equal to N_T .

By using the equation and basic rank properties, we have

$$\text{Rank}(\boldsymbol{\Omega}) + \text{Rank}(\mathbf{H}(\beta + \theta)) \geq \text{Rank}(\boldsymbol{\Omega} + \mathbf{H}(\beta + \theta)) \quad (34)$$

$$= \text{Rank}(\mathbf{A}) = N_T \Rightarrow \text{Rank}(\boldsymbol{\Omega}) \geq (N_T - 1) \quad (35)$$

So, the rank of $\boldsymbol{\Omega}$ could be either $N_T - 1$ or N_T . However, in our case, \mathbf{W} is not equal to zero and minimum required SNR ($\Gamma_{\text{req}} > 0$). Hence, rank of $\boldsymbol{\Omega}$ is $N_T - 1$ and tank of beam former is equal to one. (Rank of $(\mathbf{W}) = 1$). Finally, the optimal former \mathbf{W} can be obtained by the Eigen value decomposition of $\boldsymbol{\Omega}$ and selecting Eigen vector as the beam former.

16.2 Proof of Proposition.1:

We start the proof by re-writing constraint C_3 in the equivalent form

$$C_3: \log_2 \det(\mathbf{I}_{NR} + \mathbf{Q}_j^{-1} \mathbf{G}_j^H \text{w} \mathbf{w}^H \mathbf{G}_j) \leq R_{ER_{\max}} \quad (36)$$

$$\Rightarrow \det(\mathbf{I}_{NR} + \mathbf{Q}_j^{-1} \mathbf{G}_j^H \text{w} \mathbf{w}^H \mathbf{G}_j) \leq 2^{R_{ER_{\max}}} \quad (37)$$

We are introducing the lower bound for the above equation by using the following lemma.

Lemma: if \mathbf{A} is the positive semi definite matrices then

$$|\mathbf{I} + \mathbf{A}| \leq 1 + \text{Tr}(\mathbf{A}) \quad (38)$$

The above inequality holds if $\text{Rank}(\mathbf{A}) \leq 1$

Using the above property, equation can be written as

$$\det (\mathbf{I}_{NR} + \mathbf{Q}_j^{-1} \mathbf{G}_j^H \mathbf{w} \mathbf{w}^H \mathbf{G}_j) \geq 1 + \text{Tr} (\mathbf{Q}_j^{-1} \mathbf{G}_j^H \mathbf{w} \mathbf{w}^H \mathbf{G}_j) \quad (39)$$

$$\text{Tr} (\mathbf{Q}_j^{-1} \mathbf{G}_j^H \mathbf{w} \mathbf{w}^H \mathbf{G}_j) \leq 2^{R_{ERmax}} - 1 \quad (40)$$

$$\lambda_{\max}(\mathbf{Q}_j^{-1} \mathbf{G}_j^H \mathbf{w} \mathbf{w}^H \mathbf{G}_j) \leq (2^{R_{ERmax}} - 1) \mathbf{I}_{NR} \quad (41)$$

$$(\mathbf{Q}_j^{-1} \mathbf{G}_j^H \mathbf{w} \mathbf{w}^H \mathbf{G}_j) \preceq (2^{R_{ERmax}} - 1) \mathbf{I}_{NR} \quad (42)$$

$$\mathbf{G}_j^H \mathbf{w} \mathbf{w}^H \mathbf{G}_j \preceq (2^{R_{ERmax}} - 1) \mathbf{Q}_j \quad (43)$$

Equation 36 and equation 43 are equivalent if only if Rank (\mathbf{W}) = 1

Introduction to Convex optimization:

The Application of the convex optimisation is pervasive in fields such as Machine learning, Signal Processing and communication systems, in Marketing sector, and manufacturing industries, etc. In communication field, many complicated tasks are converted in to the convex optimization forms as these methods facilitate their analytical and numerical solutions. In these convex optimization methods, we consider the convex function along with the convex constraints. These methods are important in engineering fields as local optimum is considered as the global optimum and a rigorous optimality condition and duality form for verifying the optimal solution. In addition, many algorithms exist for finding the optimal solution of convex problem efficiently. There have been many significant researches in this optimization like interior-point method, conic optimization, etc. over the last decades.

$$\begin{aligned} & \text{Minimize } f_0(x) \\ & \text{Subject to } f_i(x) \leq b_i \quad i=1, 2, 3, \dots, m \\ & \quad \quad \quad h_i(x) = 0 \quad i=1, 2, 3, \dots, p \end{aligned}$$

Where

$X \in R^n$ is the optimization variable

$f_0 : R^n \rightarrow R$ cost function or our objective function

$f_i : R^n \rightarrow R$, $i = 1, \dots, m$, are the inequality constraint functions.

$h_i : R^n \rightarrow R$ are the set of equality constraint functions.

Optimum Value:

$$p^* = \inf \{ f_0(x) \mid f_i(x) \leq 0, i = 1, \dots, m, \quad h_i(x) = 0, i = 1, \dots, p \}$$

$p^* = \text{infinity}$; if problem is infeasible (no x satisfies the constraints)

p^* = minus infinity if problem is unbounded below

The above Form represents the standard convex method optimization form with equality and the inequality contrarians. The point x is feasible if $x \in \text{dom } f_0$ and it satisfies the set of given constrains. The feasible set is optimal set if $f_0(x) = p^*$; and if x is locally optimal there is $R > 0$ such that x is optimal for

Minimize (over z) $f_0(z)$

$$f_i(z) \leq 0$$

$$\text{mod}(z - x)_2 \leq R$$

REMARK: "In convex optimization methods, the local point is considered as globally optimal points"

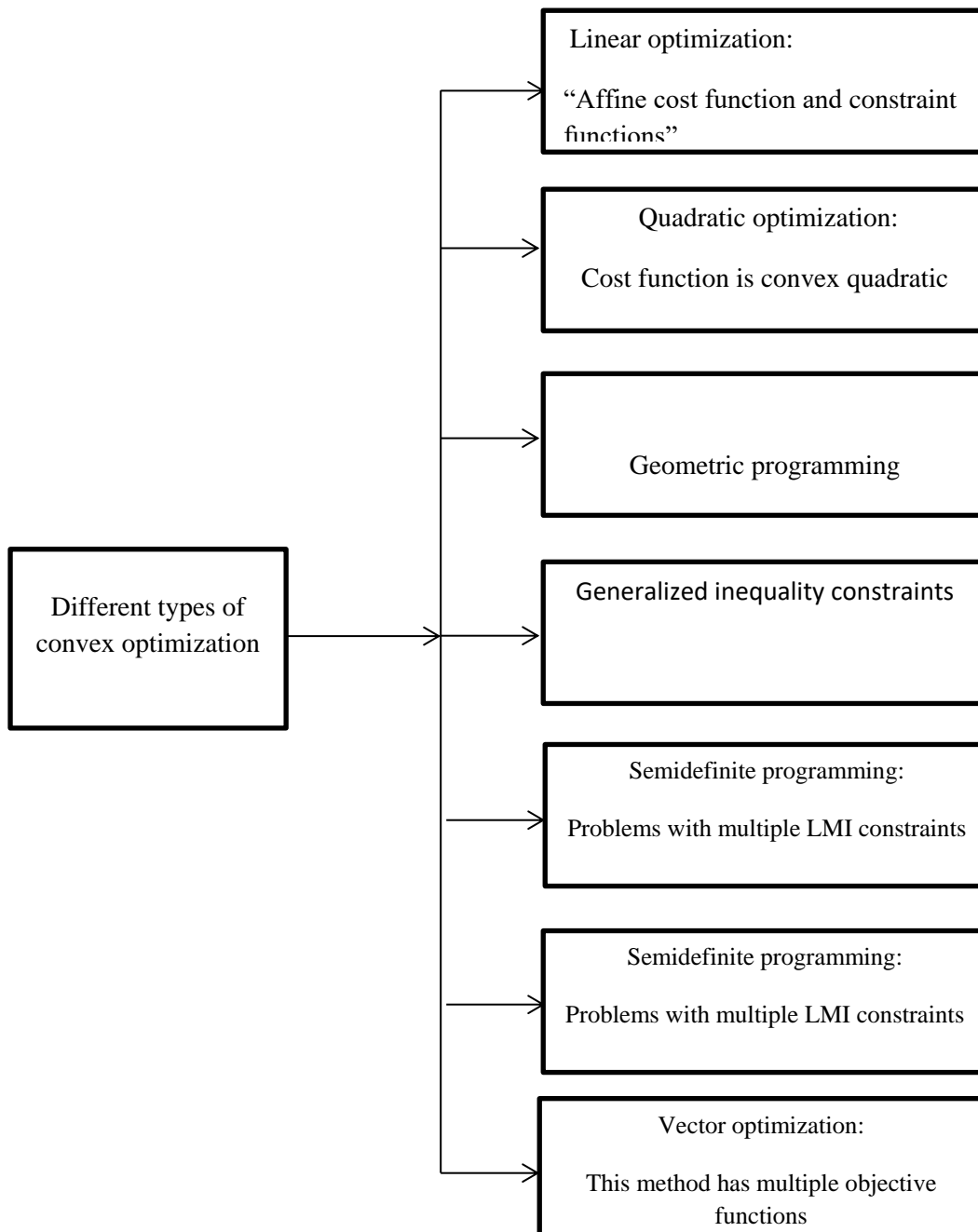

The above figure illustrates the different types of convex optimization approaches

REMARK: “ x is optimal solution if it is feasible and $\forall f_0(x)^T (y-x) \geq 0$ for all feasible y ”.

Introduction to Convex Equivalent Problems: In this section, we see the different equivalent form of the convex problems. Two Problems are said to be equivalent when the solution of one problem readily obtain from the other problem and vice versa. However, the transformation should preserve the convexity.

Some common transformation that preserve the convexity:

- 1- eliminating equality constraints (or) introducing equality constraints
- 2- Introducing slack variables for linear inequalities.
- 3- minimizing over some variables
- 4- epigraph form

Eliminating Equality Constraints:

$$\begin{aligned} & \text{Minimize } f_0(x) \\ & \text{Subject to } f_i(x) \leq b_i \quad i=1, 2, 3, \dots, m \\ & \quad \quad \quad Ax = b \end{aligned}$$

Is equivalent to

$$\begin{aligned} & \text{Minimize (over } z) \quad f_0(Fz + x_0) \\ & \text{Subject to } f_i(Fz + x_0) \leq 0 \quad i = 1, 2, \dots, m \end{aligned}$$

Where F and x_0 are such that $Ax = b \Leftrightarrow x = Fz + x_0$ for some z

Here, we should take a care while we choosing the matrix F such that columns of the F span the basis of A and x_0 is any particular solution of the $Ax = b$.

Introducing Equality Constraints:

$$\begin{aligned} & \text{Minimize } f_0(A_0x + b_0) \\ & \text{Subject to } f_i(A_ix + b_i) \leq 0, \quad i = 1, \dots, m \end{aligned}$$

is equivalent to

$$\begin{aligned} & \text{Minimize (over } x, s) \quad f_0(y_0) \\ & \text{Subject to } f_i(y_i) \leq 0, \quad i = 1, \dots, m \\ & \quad \quad \quad y_i = A_ix + b_i, \quad i = 0, 1, \dots, m \end{aligned}$$

Here, we are introducing the equality constraint by introducing the extra variable.

Introducing slack variables for linear Inequalities:

It is technique to transform the inequality constraint to equality constraint by adding an extra variable with lower bound of zero

$$\begin{aligned} & \text{Minimize } f_0(x) \\ & \text{Subject to } a_i^T x \leq b_i, i = 1 \dots m \end{aligned}$$

Is equivalent to

$$\begin{aligned} & \text{Minimize (over } x, s) f_0(x) \\ & \text{Subject to } a_i^T x + s_i = b_i, i = 1 \dots m \\ & \quad s_i \geq 0, i = 1 \dots m \end{aligned}$$

Binding constraint: if associated slack variable with given constraint is zero

Non-Binding: if the associated slack variable is positive

Infeasible: the given slack variable is negative in state.

Epigraph form:

$$\begin{aligned} & \text{Minimize (over } x, t) \quad t \\ & \text{Subject to } f_0(x) - t \leq 0 \\ & \quad f_i(x) \leq 0, \quad i = 1 \dots m \\ & \quad Ax = b \end{aligned}$$

In convex optimization, Epigraph of function is defines as $f: R^n \rightarrow R$ and consist of set of points lying on or above the graph

$$\text{Epi } f = \{(x, t) : x \in R^n, t \in R, t \geq f(x)\} \subseteq R^{n+1}$$

If we consider the strict inequality, then above form become as follows

$$\text{Epi } f = \{(x, t) : x \in R^n, t \in R, t > f(x)\} \subseteq R^{n+1}$$

Minimizing over some variables:

$$\begin{aligned} & \text{Minimize } f_0(x_1, x_2) \\ & \text{Subject to } f_i(x_1) \leq 0, i = 1, \dots, m \end{aligned}$$

Is equivalent to

$$\begin{aligned} & \text{Minimize } \tilde{f}_0(x_1) \\ & \text{Subject to } f_i(x_1) \leq 0, i = 1, \dots, m \end{aligned}$$

where $\tilde{f}_0(x_1) = \inf_{x_2} f_0(x_1, x_2)$

Introduction to Semi Definite Programming (SDP): In this Program, we minimize the linear function subjected to the constraint which is combination of symmetric matrices is positive symmetric. It is flexible method as we convert the linear program, quadratic program into the SDP and using in many applications in engineering problems and combinatorial optimization. In general, this method is not harder to solve and much more general than Linear programming (LP). For instance, most of the interior-point methods of linear programming (LP) have been generalized into the Semi Definite Programming (SDP).

Let we consider the minimization of linear function of variable $y \in R^m$ and subjected to the matrix inequality

$$\begin{aligned} & \text{Minimize } c^T y \\ & \text{Subject to } x_1 F_1 + x_2 F_2 + \dots + x_n F_n + G \leq 0 \\ & Ax = b \end{aligned}$$

Where F_i and $G \in S^K$

The inequality constraint is called Linear Matrix In-Equality (LMI)

Let we consider other scenario where we encounter with multiple LMI constraints

$$x_1 F_1 + x_2 F_2 + \dots + x_n F_n + G \quad x_1 F_1^\wedge + x_2 F_2^\wedge + \dots + G^\wedge$$

Is equivalent to the

$$x_1 \begin{bmatrix} F_1 & 0 \\ 0 & F_1^\wedge \end{bmatrix} + x_2 \begin{bmatrix} F_2 & 0 \\ 0 & F_2^\wedge \end{bmatrix} + \dots + x_n \begin{bmatrix} F_n & 0 \\ 0 & F_n^\wedge \end{bmatrix} + \begin{bmatrix} G & 0 \\ 0 & G^\wedge \end{bmatrix} \leq 0$$

In cost function, the given problem data are the vector $C \in R^m$ and the $N+1$ symmetric matrices $F_1, F_2, \dots, F_n \in R^{n \times n}$, and the Inequality sign $F(x) \geq 0$ which means that $F(x)$ is the semi positive definite i.e $z^T F(x) z \geq 0$ for all $z \in R^n$. The semi definite programs is a convex optimization problem as the constraints and objective functions are convex in nature i.e $F(x) \geq 0$ and $F(y) \geq 0$ for all $\mu, 0 \leq \mu \leq 1$,

Then according the convex function definition

$$F(\mu x + (1 - \mu)y) = \mu F(x) + (1 - \mu)F(y) \geq 0$$

semi definite programming may appear as specialized program but we can see it as a special case in many optimization problems.

Linear Program to Semi Definite Program:

For example, we consider the Linear Programming (LP)

$$\text{Minimize } c^T x$$

$$\text{Subject to } Ax + b \geq 0$$

Here the inequality interprets us the component wise inequality. As a vector $v \geq 0$ (component wise) if it is the positive semi definite matrix then we can express it as the semi definite program with

$$F(x) = \text{diag}(Ax+b), \text{ i.e.}$$

$$F_0 = \text{diag}(b), F_i = \text{diag}(a_i) \quad i=1,2,3,\dots,m$$

Form above notation $A = [a_1, a_2, \dots, a_m] \in R^{n \times m}$ and in this scenario the feasible set form a polyhedral and boundaries are not in curve shape as in general Semi definite program.

Nonlinear program to Semi definite Program:

We can also convert the nonlinear programming into SDP. However, we can't cast into the linear programming

Consider the following example

$$\text{Minimize } \frac{(c^T x)^2}{d^2 x}$$

$$\text{Subject to } Ax + b \geq 0$$

Where the assumption is that the $d^2 x \geq 0$ whenever $Ax + b \geq 0$. Here, we are introducing the auxiliary variable as constraint by setting the objective function as the upper bound.

So new form of the problem is

Minimize t

Subject to $Ax + b \geq 0$

$$\frac{(C^T x)^2}{d^T x} \leq t$$

From above Problem we have nonlinear convex constraint. The above two constraints that we convert into the linear matrix inequality in the matrix form with variables x and t .

Minimize t

$$\text{Subject to } \begin{bmatrix} \text{diag}(Ax + b) & 0 & 0 \\ 0 & t & C^T x \\ 0 & C^T x & d^T x \end{bmatrix} \geq 0$$

Thus, we convert the non-linear programming into the semi definite programming. Here, we consider the small trick that is Schur matrix which converts the nonlinear inequality in to the linear matrix inequality.

Schur matrix represented as

$$\begin{bmatrix} t & C^T x \\ C^T x & d^T x \end{bmatrix} \geq 0$$

The above matrix equivalent to the $d^T x \geq 0$ and $t - \frac{(C^T x)^2}{d^T x}$ (with $t \geq 0$ and $C^T x = 0$ if $d^T x = 0$). However, In our problem, we are assumed that $Ax + b \geq 0$ which implies that $d^T x > 0$. Thus the expression $t - \frac{(C^T x)^2}{d^T x}$ is called schur complement of $d^T x$. This is, in fact, key step to convert the nonlinear inequality into the liner matrix inequality.

Second order cone program SOCP into the SDP:

Here also, we use the schur technique for the conversion.

SOCP:

Minimize $f^T x$

Subjected to $\|A_i x + b_i\|_2 \leq C_i^T x + d_i \quad i=1,2,\dots,m$

Is equivalent to

SDP:

$$\begin{aligned} & \text{Minimize } f^T x \\ & \text{Subjected to } \begin{bmatrix} (C_i^T x + d_i)I & A_i x + b_i \\ A_i x + b_i & C_i^T x + d_i \end{bmatrix} \succeq 0 \quad i=1,2,\dots,m \end{aligned}$$

The primary advantage of the SDP is easily and efficiently solvable both in theory and in practice. In addition unified capability i.e. we can convert the other programs such as Linear Programming (LP) and Quadratic Programming etc. into the SDP.

DUALITY:

Let us consider the standard convex optimization problem

$$\begin{aligned} & \text{Minimize } f_0(x) \\ & \text{Subject to } f_i(x) \leq b_i \quad i=1, 2, 3, \dots, m \\ & \quad \quad \quad h_i(x) = 0 \quad i=1, 2, 3, \dots, p \end{aligned}$$

Where

$x \in R^n$ is the optimization variable

$f_0 : R^n \rightarrow R$ cost function or our objective function

$f_i : R^n \rightarrow R, i = 1, \dots, m$, are the inequality constraint functions.

$h_i : R^n \rightarrow R$ are the set of equality constraint functions.

Here, we are making assumption that the domain $D = \bigcap_{i=0}^m \text{dom } f_i \cap \bigcap_{i=0}^p \text{dom } h_i$ is non empty, and we denote the optimal value as p^* .

The fundamental idea of Varangian Lagrange duality is to consider the sum of weighted constraints along with the cost function as the new objective function for minimizing.

The basic idea in Lagrange duality is to take the constraints in (1) into account by augmenting the objective function with a weighted sum of the constraint functions.

Thus, the above convex optimization problem can be written as $L: R^n \times R^m \times R^p \rightarrow R$

$$L(x, \lambda, v) = f_0(x) + \sum_{i=1}^m \lambda_i f_i(x) + \sum_{i=1}^p v_i h_i(x)$$

In above equation, λ_i, v_i are called Lagrange or duality vectors associated with the inequality and equality constraints respectively.

The Lagrange Dual function: we define the Lagrange dual function (or just a dual function) $g: R^m \times R^p \rightarrow R$ as a minimum value of the Lagrange over the $\lambda \in R^m$ and $v \in R^p$

$$g(\lambda, v) = \text{Inf}_{x \in D} (f_0(x) + \sum_{i=1}^m \lambda_i f_i(x) + \sum_{i=1}^p v_i h_i(x))$$

Here, $g(\lambda, v)$ is a convex function though the standard problem is non-convex problem and it is unbounded below when it takes the value as minus infinity.

Lower bounds on optimal value: Lagrange method is the key method for finding the lower bound of the optimal value P^* of standard problem when for any $\lambda \geq 0, v$

$$g(\lambda, v) \leq P^*$$

This is an important property and we can easily verified. Let suppose we have the optimal point x^* which implies $f_i(x^*) \leq 0$ and $h_i(x^*) = 0$.

So the standard form of the Lagrange

$$L(x^*, \lambda, v) = f_0(x^*) + \sum_{i=1}^m \lambda_i f_i(x^*) + \sum_{i=1}^p v_i h_i(x^*)$$

Hence

$$g(\lambda, v) = \text{Inf}_{x \in D} L(x, \lambda, v) \leq L(x^*, \lambda, v) \leq f_0(x^*)$$

$$g(\lambda, v) \leq f_0(x^*)$$

Remark: if $\lambda \geq 0$, then $g(\lambda, v) \leq P^*, g(\lambda, v) = \text{Inf}_{x \in D} L(x, \lambda, v) \leq L(x^*, \lambda, v) \leq f_0(x^*)$, so the minimizing all over the all feasible points x^* gives $g(\lambda, v) \leq P^*$.

For instance, we consider the standard Linear Programming form

$$\text{Minimize } C^T x$$

$$\text{Subject to } Ax=b, \text{ and } x \geq 0$$

Then the Lagrange form of LP can written as

$$L(x, \lambda, v) = C^T x + v^T (Ax - b) - \lambda^T x$$

L is the affine in x then

$$g(\lambda, v) = \text{Inf}_x L(x, \lambda, v) = \begin{cases} -b^T v & A^T v - \lambda + C = 0 \\ \text{Minus infinity} & \text{otherwise} \end{cases}$$

the lower bound property the LP is given by $P^* \geq -b^T v$ if $A^T v + C \geq 0$

The Lagrange Dual Problem:

The Lagrange form of the standard convex optimization gives the set of the lower bound points. But, it could arise the basic question that is the best lower point of set of optimal points??.

This leads to optimization problem which is as follows

$$\text{Maximize } g(\lambda, v)$$

$$\text{Subject to } \lambda \geq 0$$

This problem is called standard dual problem associated with the standard convex optimization problems. According to this context, the original problem sometimes called Primal Problem. The term dual indicates the $\lambda \geq 0$ and $g(\lambda, v) > -\infty$ and Lagrange dual problem is the convex optimization problem as the objective function is concave and we are maximizing and the constraints are in the convex form.

Weak Duality: Let suppose, the optimal value of the Lagrange duality is d^* and it is the lower bound of the standard convex problem is given by the

$$P^* \geq d^*$$

The above equality holds even when our optimization problem is non-convex. This property is called weak duality.

The weak duality hold when the P^*, d^* are infinite. For instance, we consider the Primal problem which is unbounded below (i.e. $P^* = -\infty$) then we must have the optimal value of the corresponding duality is $d^* = -\infty$. The difference between $P^* - d^*$ is called optimal duality gap. This gap is key technique for finding the optimal point of Primal problem and best lowest bound of the Lagrange duality problem. The optimal duality gap must be non-negative.

Strong duality: when the optimal point of the primal problem is equal to the optimal value of the Lagrange, we call it as strong duality condition.

$$P^* = d^*$$

i.e.the optimal duality gap is zero. So, the optimal point for both Primal Lagrange is equal. In general, this condition does not hold for the type of problems. However, usually strong duality holds if the primal problem is convex i.e.

$$\text{Minimize } f_0(x)$$

$$\text{Subject to } f_i(x) \leq b_i \quad i=1, 2, 3, \dots, m$$

$$h_i(x) = 0 \quad i=1, 2, 3, \dots, p$$

Where f_0, f_1, \dots, f_m are the convex functions.

Constraint qualification and the Slater condition:

We can find many results which are establish the condition on problem, beyond the convexity, and establish the convexity called “*constraint qualification*”.

Slater condition is one of the simplest constraint qualifications. If there exist an $x \in \text{relint } \mathbf{D}$ such that

$$f_i(x) < 0 \quad i = 1, 2, 3, \dots, m \quad Ax=b$$

The point satisfies the above constraints is called strict feasibility problem. Slater condition stated that strong duality hold when slater condition holds (and the given problem is convex).

Introduction to the KKT conditions: The KKT, which are also called as Karush–Kuhn–Tucker conditions, are play an important role in many optimizations problems. In genreal, many algorithms of the convex optimization ,like the barrier method, are conceived as, or can be iterpretend as for solving the KKT conditions.

Let suppose f_0, f_1, \dots, f_m and h_0, h_1, \dots, h_m are differential functions (their domain is open) and we do not make any assumption about the convexity.

Now, let us consider the optimal point and (λ, v) are the optima points for the primal and dual problems respectively with the zero optimal gap. The optimal point x^* minimizes $L(x, \lambda, v)$ over the x , it follows that the gradient vanishes at x^* i.e.

$$\nabla f_0(x^*) + \sum_{i=1}^m \lambda_i \nabla f_i(x^*) + \sum_{i=1}^p v_i \nabla h_i(x^*) = 0$$

Thus we have the four standard conditions:

$$f_i(x^*) \leq 0 \quad i=1, 2, 3, 4, \dots, m$$

$$h_i(x^*) = 0 \quad i=1, 2, 3, 4, \dots, p$$

$$\lambda_i \geq 0 \quad i=1, 2, 3, 4, \dots, m$$

$$\lambda_i f_i(x^*) = 0 \quad i=1, 2, 3, 4, \dots, m$$

$$\nabla f_0(x^*) + \sum_{i=1}^m \lambda_i \nabla f_i(x^*) + \sum_{i=1}^p v_i \nabla h_i(x^*) = 0$$

The above five standard conditions are called standard KKT conditions.

Thus, for any optimization problem with the differentiable cost function and constraint functions, both Primal and dual optimal Point must satisfy the KKT conditions.

Now, suppose our primal problem is convex then KKT conditions are sufficient condition for their primal and dual optimal points. Let suppose we have if f_i is convex function and h_i is the affine function then $x^{\sim}, \lambda^{\sim}, v^{\sim}$ are any points which are satisfying the KKT conditions

$$f_i(x^{\sim}) \leq 0 \quad i=1,2,3,4,\dots,m$$

$$h_i(x^{\sim}) = 0 \quad i=1,2,3,4,\dots,p$$

$$\lambda_i^{\sim} \geq 0 \quad i=1,2,3,4,\dots,m$$

$$\lambda_i^{\sim} f_i(x^{\sim}) = 0 \quad i=1,2,3,4,\dots,m$$

$$\nabla f_0(x^{\sim}) + \sum_{i=1}^m \lambda_i^{\sim} \nabla f_i(x^{\sim}) + \sum_{i=1}^p v_i^{\sim} \nabla h_i(x^{\sim}) = 0$$

Then the x^{\sim} , and λ^{\sim}, v^{\sim} are primal dual optimal with zero optimal gap.